

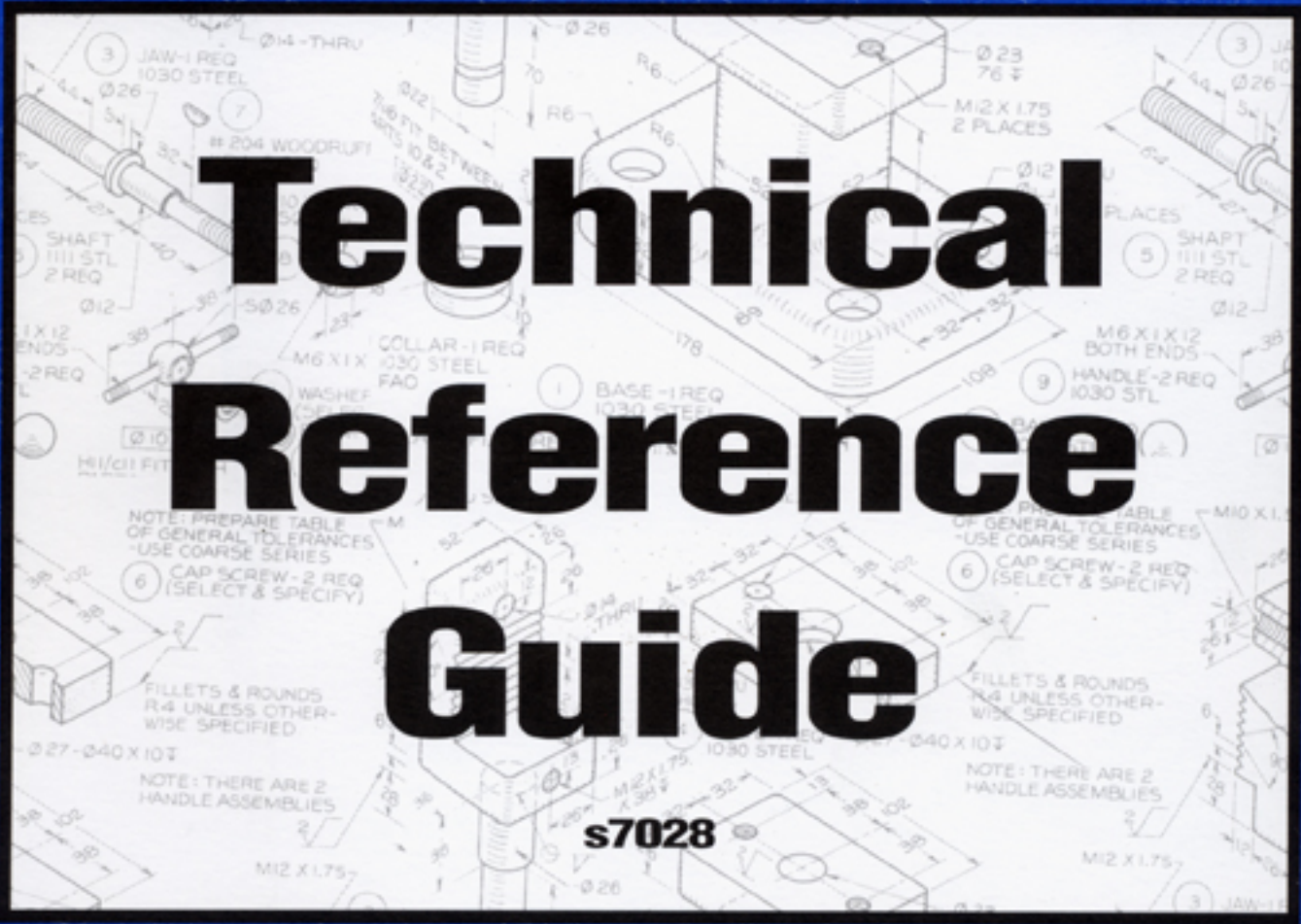

6 CAP SCREW - 2 REQ  
(SELECT & SPECIFY)

# **FASTENAL**

**INDUSTRIAL & CONSTRUCTION SUPPLIES**



# **Technical Reference Guide**

**s7028**

# Technical Reference Guide

## Table of Contents

Subject	Page #
Fastener Material Selection	1
Mechanical Properties	
Materials	3
Galling	6
Heat Treatment	7
Screw Thread Fundamentals	10
Strength of Threads	12
Platings and Coatings	13
Corrosion	15
Hydrogen Embrittlement	16
High Temperature Effects	18
Joint Design	19
Tension Control in a Bolted Joint	22
Torque Control	23
Torque and Turn Control	25
Stretch Control	25
Direct Tension Control	26
Reuse of Fasteners	27
Structural Bolts	28
Standards	30
Metric System	31
Common Specifications for Use with Fasteners	33
Appendix	34

**Disclaimer:** The following information contains extracts, data, application examples, assembly and installation applications obtained from industry standards/specifications that were represented as accurate at time of their publication. These standards/specifications are constantly being updated and so the technical details are subject to revision. Fastenal strives to present the information in an accurate manner, but we do not guarantee its completeness or validity. This information is subject to change at any time, without notice. The Fastenal Engineering Department welcomes questions regarding fastener specifications or specific customer applications, but any information provided will be subject to this Disclaimer.

The material provided in this guide is advisory only and use is completely voluntary. Fastenal makes no representations or warranties, express or implied, in connection with the information. Any use or application of this information will be at the users sole risk and responsibility. Fastenal will not be responsible for any loss, claims or damages arising out of the use or application of this information, regardless of whether the same may be known or foreseeable.

Any questions, comments or concerns may be directed to the Fastenal Company Engineering Department at (507) 454-5374, or e-mail us at [engineer@fastenal.com](mailto:engineer@fastenal.com)

## Fastener Material Selection

There is no one fastener material that is right for every environment. Selecting the right fastener material from the vast array of materials available can appear to be a daunting task. Careful consideration may need to be given to strength, temperature, corrosion, vibration, fatigue and many other variables. However, with some basic knowledge and understanding, a well thought out evaluation can be made.

### Mechanical Properties

Most fastener applications are designed to support or transmit some form of externally applied load. If the strength of the fastener is the only concern, there is usually no need to look beyond carbon steel. Over 90% of all fasteners are made of carbon steel. In general, considering the cost of raw materials, non-ferrous should be considered only when a special application is required.

#### Tensile Strength

The most widely associated mechanical property associated with standard threaded fasteners is tensile strength. Tensile strength is the maximum tension-applied load the fastener can support prior to or coinciding with its fracture (see figure 1).

Tensile load a fastener can withstand is determined by the formula

$$P = S_t \times A_s$$

where

$P$  = tensile load (lb., N)

$S_t$  = tensile strength (psi, MPa)

$A_s$  = tensile stress area (sq. in, sq. mm)

Example (see appendix for  $S_t$  and  $A_s$  values)

3/4-10 x 7" SAE J429 Grade 5 HCS

$S_t = 120,000$  psi

$A_s = 0.3340$  sq. in

$P = 120,000$  psi x  $0.3340$  sq. in

$P = 40,080$  lb.

For this relationship, a significant consideration must be given to the definition of the tensile stress area,  $A_s$ . When a standard threaded fastener fails in pure tension, it typically fractures through the threaded portion (this is characteristically its smallest area). For this reason, the tensile stress area is calculated through an empirical formula involving the nominal diameter of the fastener and the thread pitch. Tables stating this area are provided for you in the appendix.

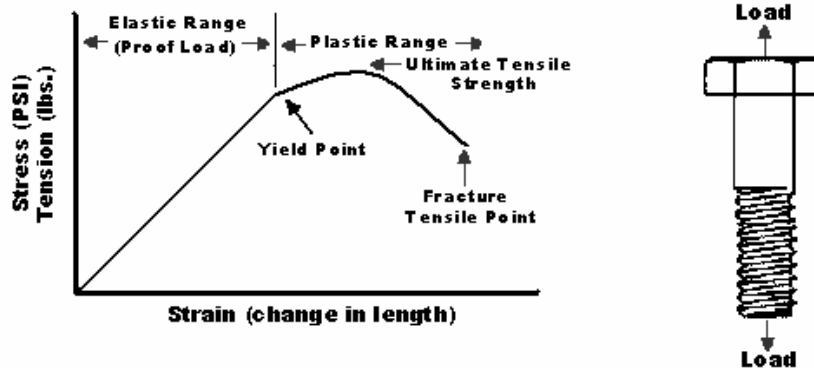

**Figure 1 Tensile Stress-Strain Diagram**

#### Proof Load

The proof load represents the usable strength range for certain standard fasteners. By definition, the proof load is an applied tensile load that the fastener must support without permanent deformation. In other words, the bolt returns to its original shape once the load is removed.

Figure 1 illustrates a typical stress-strain relationship of a bolt as a tension load is applied. The steel possesses a certain amount of elasticity as it is stretched. If the load is removed and the fastener is still within the elastic range, the fastener will always return to its original shape. If, however, the load applied causes the fastener to be brought past its yield point, it now enters the plastic range. Here, the steel is no longer able to return to its original shape if the load is removed. The yield strength is the point at which permanent elongation occurs. If we would continue to apply a load, we would reach a point of maximum stress known as the ultimate tensile strength. Past this point, the fastener continues to “neck” and elongate

further with a reduction in stress. Additional stretching will ultimately cause the fastener to break at the tensile point.

### *Shear Strength*

Shear strength is defined as the maximum load that can be supported prior to fracture, when applied at a right angle to the fastener's axis. A load occurring in one transverse plane is known as single shear. Double shear is a load applied in two planes where the fastener could be cut into three pieces. Figure 2 is an example of double shear.

For most standard threaded fasteners, shear strength is not a specification even though the fastener may be commonly used in shear applications. While shear testing of blind rivets is a well-standardized procedure which calls for a single shear test fixture, the testing technique of threaded fasteners is not as well designed. Most procedures use a double shear fixture, but variations in the test fixture designs cause a wide scatter in measured shear strengths.

To determine the shear strength of the material, the total cross-sectional area of the shear plane is important. For shear planes through the threads, we could use the equivalent tensile stress area ( $A_s$ ). Figure 2 illustrates two possibilities for the applied shear load. One has the shear plane corresponding with the threaded portion of the bolt. Since shear strength is directly related to the net sectional area, a smaller area will result in lower bolt shear strength. To take full advantage of strength properties, the preferred design would be to position the full shank body in the shear planes as illustrated with the joint on the right.

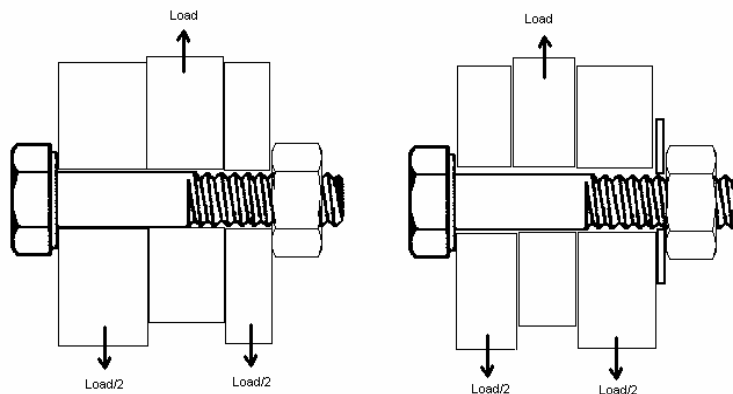

**Figure 2 Shear Planes in a Bolted Joint**

When no shear strength is given for common carbon steels with hardness up to 40 HRC, 60 % of their ultimate tensile strength is often used once given a suitable safety factor. This should only be used as an estimation.

### *Fatigue Strength*

A fastener subjected to repeated cyclic loads can suddenly and unexpectedly break, even if the loads are well below the strength of the material. The fastener fails in fatigue. The fatigue strength is the maximum stress a fastener can withstand for a specified number of repeated cycles prior to its failure.

### *Torsional Strength*

Torsional strength is a load usually expressed in terms of torque, at which the fastener fails by being twisted off about its axis. Tapping screws and socket set screws require a torsional test.

## **Other Mechanical Properties**

### *Hardness*

Hardness is a measure of a material's ability to resist abrasion and indentation. For carbon steels, Brinell and Rockwell hardness testing can be used to estimate tensile strength properties of the fastener.

### *Ductility*

Ductility is a measure of the degree of plastic deformation that has been sustained at fracture. In other words, it is the ability of a material to deform before it fractures. A material that experiences very little or no plastic deformation upon fracture is considered brittle. A reasonable indication of a fastener's ductility is the ratio of its specified minimum yield strength to the minimum tensile strength. The lower this ratio the more ductile the fastener will be.

#### *Toughness*

Toughness is defined as a material's ability to absorb impact or shock loading. Impact strength toughness is rarely a specification requirement. Besides various aerospace industry fasteners, ASTM A320 Specification for Alloy Steel Bolting Materials for Low-Temperature Service is one of the few specifications that require impact testing on certain grades.

### **Materials**

#### **Carbon Steel**

Over 90% of fasteners manufactured use carbon steel. Steel has excellent workability, offers a broad range of attainable combinations of strength properties, and in comparison with other commonly used fastener materials, is less expensive.

The mechanical properties are sensitive to the carbon content, which is normally less than 1.0%. For fasteners, the more common steels are generally classified into three groups: low carbon, medium carbon and alloy steel.

#### *Low Carbon Steels*

Low carbon steels generally contain less than 0.25% carbon and cannot be strengthened by heat-treating; strengthening may only be accomplished through cold working. The low carbon material is relatively soft and weak, but has outstanding ductility and toughness; in addition, it is machinable, weldable and is relatively inexpensive to produce. Typically, low carbon material has a yield strength of 40,000 psi, tensile strengths between 60,000 and 80,000 psi and a ductility of 25% EL. The most commonly used chemical analyses include AISI 1006, 1008, 1016, 1018, 1021, and 1022.

SAE J429 Grade 1, ASTM A307 Grade A are low carbon steel strength grades with essentially the same properties. ASTM A307 Grade B is a special low carbon steel grade of bolt used in piping and flange work. Its properties are very similar to Grade A except that it has added the requirement of a specified maximum tensile strength. The reason for this is that to make sure that if a bolt is inadvertently overtightened during installation, it will fracture prior to breaking the cast iron flange, valve, pump, or expensive length of pipe. SAE J429 Grade 2 is a low carbon steel strength grade that has improved strength characteristics due to cold working.

#### *Medium Carbon Steels*

Medium carbon steels have carbon concentrations between about 0.25 and 0.60 wt. These steels may be heat treated by austenizing, quenching and then tempering to improve their mechanical properties. The plain medium carbon steels have low hardenabilities and can be successfully heat-treated only in thin sections and with rapid quenching rates. This means that the end properties of the fastener are subject to size effect. Notice on the SAE J429 Grade 5, ASTM A325 and ASTM A449 specifications that their strength properties "step down" as the diameters increase.

On a strength-to-cost basis, the heat-treated medium carbon steels provide tremendous load carrying ability. They also possess an extremely low yield to tensile strength ratio; making them very ductile. The popular chemical analyses include AISI 1030, 1035, 1038, and 1541.

#### *Alloy Steels*

Carbon steel can be classified as an alloy steel when the manganese content exceeds 1.65%, when silicon or copper exceeds 0.60% or when chromium is less than 4%. Carbon steel can also be classified as an alloy if a specified minimum content of aluminum, titanium, vanadium, nickel or any other element has been added to achieve specific results. Additions of chromium, nickel and molybdenum improve the capacity of the alloys to be heat treated, giving rise to a wide variety of strength to ductility combinations.

SAE J429 Grade 8, ASTM A354 Grade BD, ASTM A490, ASTM A193 B7 are all common examples of alloy steel fasteners.

### **Stainless Steel**

Stainless steel is a family of iron-based alloys that must contain at least 10.5% chromium. The presence of chromium creates an invisible surface film that resists oxidation and makes the material “passive” or corrosion resistant. Other elements, such as nickel or molybdenum are added to increase corrosion resistance, strength or heat resistance.

Stainless steels can be simply and logically divided into three classes on the basis of their microstructure; **austenitic, martensitic or ferritic**. Each of these classes has specific properties and basic grade or “type.” Also, further alloy modifications can be made to alter the chemical composition to meet the needs of different corrosion conditions, temperature ranges, strength requirements, or to improve weldability, machinability, work hardening and formability.

**Austenitic stainless steels** contain higher amounts of chromium and nickel than the other types. They are not hardenable by heat treatment and offer a high degree of corrosion resistance. Primarily, they are non-magnetic; however, some parts may become slightly magnetic after cold working. The tensile strength of austenitic stainless steel varies from 75,000 to 105,000 psi.

18-8 Stainless steel is a type of austenitic stainless steel that contains approximately 18% chromium and 8% nickel. Grades of stainless steel in the 18-8 series include, but not limited to; 302, 303, 304 and XM7.

#### *Common austenitic stainless steel grades:*

- 302: General purpose stainless retains untarnished surface finish under most atmospheric conditions and offers high strength at reasonably elevated temperatures. Commonly used for wire products such as springs, screens, cables; common material for flat washers.
- 302HQ: Extra copper reduces work hardening during cold forming. Commonly used for machine screws, metal screws and small nuts
- 303: Contains small amounts of sulfur for improved machinability and is often used for custom-made nuts and bolts.
- 304: Is a low carbon-higher chromium stainless steel with improved corrosion resistance when compared to 302. 304 is the most popular stainless for hex head cap screws. It is used for cold heading and often for hot heading of large diameter or long bolts.
- 304L: Is a lower carbon content version of 304, and therefore contains slightly lower strength characteristics. The low carbon content also increases the 304L corrosion resistance and welding capacity.
- 309 & 310: Are higher in both nickel and chromium content than the lower alloys, and are recommended for use in high temperature applications. The 310 contains extra corrosion resistance to salt and other aggressive environments.
- 316 & 317: Have significantly improved corrosion resistance especially when exposed to seawater and many types of chemicals. They contain molybdenum, which gives the steel better resistance to surface pitting. These steels have higher tensile and creep strengths at elevated temperatures than other austenitic alloys.

#### *Austenitic stainless steel limitations:*

- They are suitable only for low concentrations of reducing acids.
- In crevices and shielded areas, there might not be enough oxygen to maintain the passive oxide film and crevice corrosion might occur.
- Very high levels of halide ions, especially the chloride ion can also break down the passive surface film.

**Martensitic stainless steels** are capable of being heat treated in such a way that the martensite is the prime microconstituent. This class of stainless contains 12 to 18% chromium. They can be hardened by heat treatment, have poor welding characteristics and are considered magnetic. The tensile strength of

martensitic stainless steel is approximately 70,000 to 145,000 psi. This type of stainless steel should only be used in mild corrosive environments.

*Common martensitic stainless steel grades:*

- 410: A straight chromium alloy containing no nickel. General-purpose corrosion and heat resisting, hardenable chromium steel. It can be easily headed and has fair machining properties. Due to their increased hardness, are commonly used for self-drilling and tapping screws. These are considered very inferior in corrosion resistance when compared with some of the 300.
- 416: Similar to 410 but has slightly more chromium, which helps machinability, but lowers corrosion resistance.

**Ferritic stainless steels** contain 12 to 18% chromium but have less than 0.2% carbon. This type of steel is magnetic, non-hardenable by heat treatment and has very poor weld characteristics. They should not be used in situations of high corrosion resistance requirements.

*Common ferritic stainless steel grades:*

- 430: Has a slightly higher corrosion resistance than Type 410 stainless steel.

**Precipitation Hardening Stainless Steel**

Precipitation hardening stainless steels are hardenable by a combination of low-temperature aging treatment and cold working. Type 630, also known commercially as 17-4 PH, is one of the most widely used precipitated hardened steels for fasteners. They have relatively high tensile strengths and good ductility. The relative service performance in both low and high temperatures is reasonably good.

The following diagram illustrates the compositional and property connection for stainless steel.

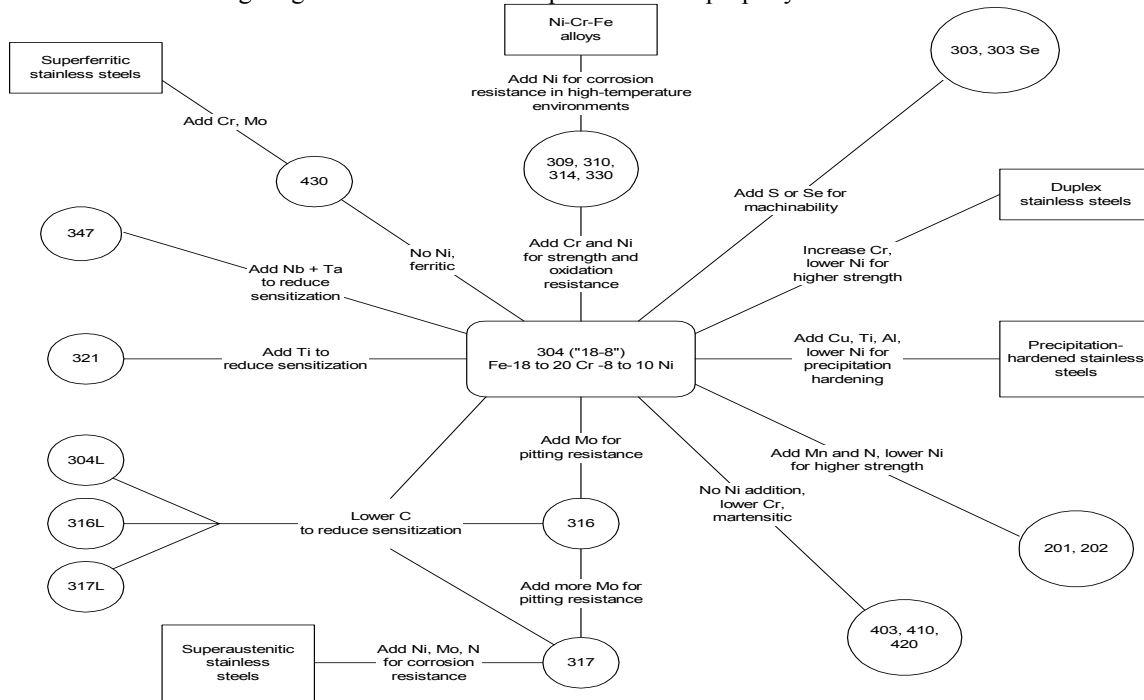

**Nickel and High Nickel Alloys**

The family of nickel alloys offer some remarkable combinations of performance capabilities. Mechanically they have good strength properties, exceptional toughness and ductility, and are generally immune to stress corrosion. Their corrosion resistance properties and performance characteristics in both elevated and subzero temperatures is superior. Unfortunately, nickel based alloys are relatively expensive. The two most popular nickel alloys used in fastening are the nickel-copper and nickel-copper-aluminum types. Nickel-Copper alloy, known commercially as by such trade names as Monel. Monel 400 is the most commonly used nickel-copper alloy for cold forming; contains excellent corrosion in heat and salt

water. Nickel-Copper-Aluminum alloy, commercially tradenamed K-Monel, is an extension of a nickel-copper alloy. The aluminum and titanium elements improve the response heat treatment and significantly enhance the mechanical strength.

Inconel & Hastelloy: These are considered outstanding materials for applications where fastenings must contain high strength and resistance to oxidation in extreme environments such as elevated temperatures and various acidic environments. There are several grades of Inconel and Hastelloy, most are proprietary, and practically all are trade named, each with their own strength and corrosion characteristics.

### **Aluminum**

Aluminum is synonymous with lightweight. Once thought as only a single costly metal, aluminum now constitutes an entire family of alloys. Aluminum can be alloyed with other metals to produce suitable alloys with variety of industrial and consumer goods. Aluminum fasteners weigh about 1/3 those of steel. Pure aluminum has a tensile strength of about 13,000-PSI. The strength properties of the more commonly used alloys are quite high and can actually approach that of mild steel. Thus, the strength-to-weight ratio of aluminum fasteners is generally better than any other commercially available fastener material. Aluminum is non-magnetic. Its electrical and thermal conductivity are good. Aluminum is machinable and it cold forms and hot forges easily.

### **Silicon Bronze**

Silicon bronze is the generic term for various types of copper-silicon alloys. Most are basically the same with high percentages of copper and a small amount of silicon. Manganese or aluminum is added for strength. Lead is also added for free machining qualities where required. Silicon bronze possesses high tensile strength (superior to mild steel). With its high corrosive resistance and non-magnetic properties, this alloy is ideally suited for naval construction; particularly mine sweepers.

### **Naval Bronze**

Sometimes called Naval Brass, Naval Bronze is similar to brass but has additional qualities of resistance to saline elements. This is accomplished by changing the proportions of copper, zinc and a little tin. This alloy derived its name from its ability to survive the corroding action of salt water.

### **Copper**

Copper has some very interesting performance features. Its electrical and thermal conductivity are the best of any of non-precious metals and has decent corrosion resistance in most environments. Copper, and its alloys, are non-magnetic.

### **Brasses**

Brass is composed of copper and zinc and is the most common copper-based alloy. They retain most of the favorable characteristics of pure copper, with some new ones, and generally cost less. The amount of copper content is important. Brass alloys with less copper are generally stronger and harder, but less ductile.

## **Galling**

Thread galling is a common, yet seldom-understood problem with threaded fasteners. Galling is often referred to as a *cold-welding* process, which can occur when the surfaces of male and female threads come in contact with heavy pressure. The truly annoying aspect of fastener galling is that these same nuts and bolts are found to meet all required inspections (threads, material, mechanical, etc.), but yet they are still not functioning together.

Stainless steel fasteners are particularly susceptible to thread galling, although it also occurs in other alloys which self-generate an oxide surface film for corrosion purposes, such as aluminum and titanium. During the tightening of the fastener, a pressure builds between the contacting thread surfaces and breaks down the protective oxides. With the absence of the oxide coating, the metal high points can shear and lock together.

Minor galling may cause only slight damage to the thread surface and the fastener may still be removed. However, in severe cases, galling can completely weld the nut and bolt together and prevent removal of the fastener. Often times, once galling begins, if the tightening process is continued, the fastener may be twisted off or its threads stripped out.



Unfortunately, even with an understanding of the mechanism of galling, little is known on how to successfully control it. However, the probability of galling occurring can be minimized with the following measures:

- Thread lubrication is one of the most effective measures to lessen the potential for galling. The lubricant reduces friction, which is a key element in thread galling. Certain material environments, such as stainless steel fasteners used in food processing equipment, preclude the use of some lubricants. Also, attention must be given to the torque-tension relationship, which will be altered with the use of lubrication.
- Use coarse threads with a 2A-2B fit instead of fine threads. Coarse threads have a larger thread allowance and are more tolerant to abuse during handling.
- Heat contributes significantly to thread galling. Installing a fastener generates heat and high-speed installation generates significantly more heat. Lowering the wrench speed during installation and removal can be helpful.
- Avoid prevailing torque locknuts. The function of a prevailing torque locknut is to add resistance to the threads. This resistance also creates friction and heat. If a prevailing torque locknut must be used, ensure a minimal amount of threads are protruding beyond the nut.
- Mating parts of the same alloy have a greater tendency to gall than parts of dissimilar alloys having different degrees of hardness. Most stainless steels are more susceptible to galling than carbon and alloy steels. However, not all combinations of stainless steels act the same. For instance, a 400 series stainless steel nut can work well on 316 series bolts, but with a reduction in corrosion resistance.
- A smoother surface texture will lead to less frictional resistance. Rolled threads usually offer smoother surfaces than cut threads. As previously mentioned, friction increases the possibility of galling.
- Proper installation torque. If the fastener is over tightened, the threads can begin to yield which will induce friction between the mating surfaces.

### **Heat Treatment**

Heat-treating is performed to change certain characteristics of metals and alloys in order to make them more suitable for a particular kind of application. In general, heat treatment is the term for any process employed, by either heating or cooling, to change the physical properties of a metal. The goal of heat treatment is to change the structure of the material to a form, which is known to have the desired properties. The treatments induce phase transformations that greatly influence mechanical properties such as strength, hardness, ductility, toughness, and wear resistance of the alloys. The large number of service requirements and amount of alloys available make for a considerable amount of heat-treating operations.

### **Heat Treatment of Carbon Steels and Carbon Alloy Steels**

Carbon steels and carbon alloy steels can be heat treated for the purpose of improving properties such as hardness, tensile and yield strength. The desired results are accomplished by heating in temperature ranges where a phase or combinations of phases are stable, and/or heating or cooling between temperature ranges in which different phases are stable.

The structure of steel is composed of two variables:

1. Grain Structure - The arrangement of atoms in a metal.
2. Grain Size - The size of the individual crystals of metal. Large grain size is generally associated with low strength, hardness, and ductility.

After being formed, the material is usually quenched and tempered to produce a martensitic structure that produces the most sought after mechanical properties in steel fasteners. Martensite is formed by rapid cooling or quenching from austenizing temperatures using a quenching medium, such as oil, water or air, that will transfer heat away from the hot parts at a sufficient rate. The quenched martensitic structure, which is hard but brittle, is then tempered in order to increase the ductility and decrease the hardness to specified levels. During the quenching treatment, it is impossible to cool the specimen at a uniform rate throughout. The surface of the specimen will always cool more rapidly than the interior regions.

Therefore, the austenite will transform over a range of temperatures, yielding a possible variation of microstructure and properties with position within the material.

The successful heat treatment of steels to produce a predominantly martensitic microstructure throughout the cross section depends mainly on three factors:

1. the composition of the alloy
2. the type and character of the quenching medium
3. the size and shape of the specimen

### *Hardenability*

The influence of alloy composition on the ability of a steel alloy to transform to martensite for a particular quenching treatment is related to a parameter called hardenability. For every different steel alloy there is a specific relationship between their mechanical properties and their cooling rate. Hardenability is not “hardness” which is a resistance to indentation; rather, hardness measurements are utilized to determine the extent of a martensitic transformation in the interior of the material. A steel alloy that has a high hardenability is one that hardens, or forms martensite, not only at the surface but also to a large degree throughout the entire interior. In other words, hardenability is a measure of the depth to which a specific alloy may be hardened.

The following elements have known effects on the properties of steel:

Carbon ( C ): Primary alloying element: Principle hardening element: Essential for the formation of martensite during hardening

Manganese ( Mn ): Increases strength and hardness: Increases hardenability

Phosphorus ( P ): Considered an impurity, can cause brittleness at low temperatures

Sulfur ( S ): Considered an impurity, can lower tensile strength at high temperatures: Improves machinability in free machining steels

Silicon ( Si ): Deoxidizer

Nickel ( Ni ): Improves toughness: Simplifies heat-treating: Increases hardenability: Decreases distortion: Improves corrosion resistance

Chromium ( Cr ): Improves hardenability: Provides wear and abrasion resistance: Improves corrosion resistance

Molybdenum ( Mo ): Improves hardenability: Non-oxidizing

Boron ( B ): Trace amounts increase hardenability: Promotes formability

Aluminum ( Al ): Controls grain size: Deoxidizer

### *Tempering*

In the as-quenched state, martensite, in addition to being very hard, is extremely brittle and cannot be used for most applications. Also, any internal stresses that may have been introduced during quenching have a weakening effect.

If the steel has been fully hardened by being quenched from above its critical temperature, tempering can be used to enhance the ductility and toughness of martensite and relieve the internal stresses. In tempering, the steel is reheated to a specific temperature below its critical temperature for a certain period of time and then cooled at a prescribed rate.

The following example will demonstrate the effectiveness of tempering:

ASTM A193 Grade B7, SAE J429 Grade 8 and ASTM A574 Socket Head Cap Screws are all made from alloy steels. In fact some alloy steel grades can be used to manufacture any of the three final products:

such as 4140 and 4142 alloy steel. The final mechanical properties are the following:

ASTM A193 B7

- Tensile Strength: 125,000 PSI minimum (2-1/2-inch and under)
- Yield Strength: 105,000 PSI minimum (2-1/2-inch and under)
- Hardness: HRC 35 Maximum

SAE J429 Grade 8

- Tensile Strength: 150,000 PSI minimum

- Proof Strength: 120,000 PSI
- Yield Strength: 130,000 PSI minimum
- Hardness: HRC 33-39

#### ASTM A574 Socket Head Cap Screw

- Tensile Strength: 180,000 PSI minimum (through ½”), 170,000 PSI minimum (above ½”)
- Proof Strength: 140,000 PSI (through ½”), 135,000 PSI (above ½”)
- Yield Strength: 153,000 PSI minimum
- Hardness: HRC 39-45 (through ½”), HRC 37-45 (above ½”)

The initial heat-treating process is relatively the same for all three products. The parts are heat treated until fully austenitized. The parts are then quenched and tempered in a liquid (oil). This final tempering temperature is what will dictate our final product. The following are the minimum tempering temperatures for each specification:

- ASTM A193 B7: 1150°F
- SAE J429 Grade 8: 800°F
- ASTM A574: 650°F

As can be seen by the results, a lower tempering temperature will produce a harder and higher tensile strength part for these alloy steels. However, the lower tempering temperatures will also mean lower service conditions, ductility, impact strength and possible fatigue life. For example a B7 has a high-temperature limitation of approximately 750-800°F. The socket head cap screws and grade 8’s have a limitation of approximately 400-500°F.

#### *Annealing*

Annealing is used to soften previously cold-worked metal by allowing it to re-crystallize. The term annealing refers to a heat treatment in which a material is exposed to an elevated temperature for an extended time period and then slowly cooled. Ordinarily, annealing is carried out to (1) relieve stresses; (2) increase softness, ductility and toughness; and/or (3) produce a microstructure. A variety of annealing heat treatments are possible.

Any annealing process consists of three stages:

1. heating to the desired temperature
2. holding or “soaking” at that temperature
3. slowly cooling, usually to room temperature

Time is the important parameter in these procedures

#### *Process Annealing*

Process annealing is a heat treatment that is used to negate the effects of cold work that is to soften and increase the ductility of a previously strain-hardened metal.

#### *Stress Relieving*

Internal residual stresses may develop in metal pieces in response to such things as cold working. Distortion and warpage may result if these residual stresses are not removed. They may be eliminated by a stress relief annealing heat treatment in which the piece is heated to the recommended temperature, held there long enough to attain a uniform temperature, and finally cooled to a room temperature in air. Stress relieving can eliminate some internal stresses without significantly altering the structure of the material.

#### *Normalizing*

Steels that have been plastically deformed by, for example, a rolling operation, consists of grains of pearlite, which are irregularly shaped and relatively large, but vary substantially in size. Normalizing is an annealing heat treatment use to refine the grains and produce a more uniform and desirable size distribution.

Normalizing is accomplished by heating the material to a temperature above its upper critical temperature. After sufficient time has been allowed for the alloy to completely transform to austenite, a procedure termed austenitizing, the metal is allowed to cool in the air.

#### *Full Anneal*

A heat treatment known as full annealing is often utilized in low- and medium-carbon steels that will be machined or will experience extensive plastic deformation during a forming operation. The full anneal cooling procedure is time consuming,

### *Spheroidizing*

Medium- and high-carbon steels having a microstructure containing coarse pearlite may still be too hard to conveniently machine or plastically deform. These steels, and in fact, any steel, may be heat treated or annealed to develop the spheroidite structure. Spheroidized steels have a maximum softness and ductility and are easily machined or deformed.

### **Screw Thread Fundamentals**

The screw thread, which has often been described as an inclined plane wrapped around a cylinder, is fundamental to the threaded fastener. There are well over 125 separate geometrical features and dimensional characteristics with the design and construction of screw threads. The following definitions, along with the figure, should help with some of the basic screw thread features.

A screw thread is considered to be a ridge of uniform section in the form of a helix on either the external or internal surface of a cylinder. Internal threads are threads on nuts and tapped holes. External threads are those on bolts, studs or screws.

The configuration of the thread in an axial plane is the thread form, or profile, and the three parts making the form are the crest, root and flanks. At the top of the threads are the crests, at the bottom the roots, and joining them is the flanks. The triangle formed when the thread profile is extended to a point at both crests and roots, is the fundamental triangle. The height of the fundamental triangle is the distance, radially measured, between sharp crest and sharp root diameters.

The distance-measured parallel to the thread axis, between corresponding points on adjacent threads, is the thread pitch. Unified screw threads are designated in threads per inch. This is the number of complete threads occurring in one inch of threaded length. Metric thread pitch is designated as the distance between threads (pitch) in millimeters:

On an internal thread, the diameter at the crests is the minor diameter and at the roots the major diameter. On an external thread (as illustrated on the following diagram), the diameter at the thread crests is the major diameter, and at its thread root is the minor diameter.

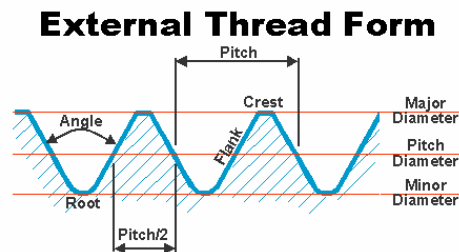

The flank angle is the angle between a flank and a perpendicular to the thread axis. When flanks have the same angle, the thread is a symmetrical thread and the flank angle is termed half-angle of thread. Unified screw threads have a 30-degree flank angle and are symmetrical. This is why they are commonly referred to as 60-degree threads.

Pitch diameter is the diameter of a theoretical cylinder that passes through the threads in such a position that the widths of the thread ridges and thread grooves are equal. These widths, in a perfect world, would each equal one-half of the thread pitch.

An intentional clearance is created between mating threads known as the allowance. This ensures that when both the internal and external threads are manufactured there will be a positive space between them. For fasteners, the allowance is generally applied to the external thread. Tolerances are specified amounts

by which dimensions are permitted to vary for convenience of manufacturing. The tolerance is the difference between the maximum and minimum permitted limits.

*Thread Fit*

Thread fit is the combination of allowances and tolerances and is a measure of tightness or looseness between them. A clearance fit is one that provides a free running assembly and an interference fit is one having specified limits of thread size that always result in a positive interference between the threads when assembled.

For Unified inch screw threads there are six classes of fit: 1B, 2B and 3B for internal threads; and 1A, 2A and 3A for external threads. All are considered clearance fits. This means they assemble without interference. The higher the class number, the tighter the fit. The ‘A’ designates an external thread, and ‘B’ designates an internal thread.

- Classes 1A and 1B are considered an extremely loose tolerance thread fit. This class is suited for quick and easy assembly and disassembly. For mechanical fasteners, this thread fit is rarely specified.
- Classes 2A and 2B offer optimum thread fit that balances fastener performance, manufacturing economy and convenience. Nearly 90 % of all commercial and industrial fasteners produced in North America have this class of thread fit.
- Classes 3A and 3B are suited for close tolerance fasteners. These fasteners are intended for service where safety is a critical design consideration. This class of fit has restrictive tolerances and no allowance. Socket products generally have a 3A thread fit

The following illustration demonstrates the pitch diameter allowances on a 3/4-10 bolt and nut.

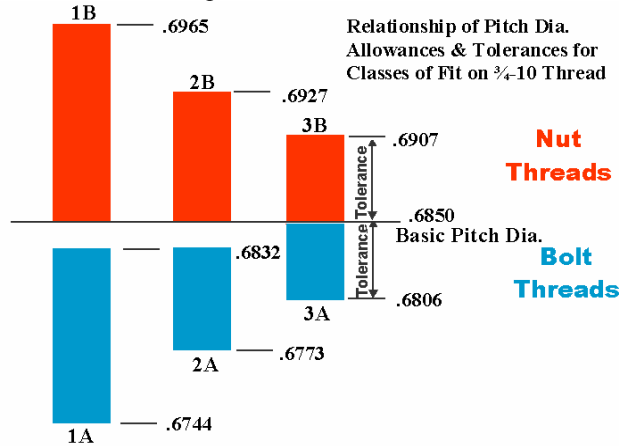

The axial distance through which the fully formed threads of both the internal and external threads are in contact is known as the length of thread engagement. The depth of thread engagement is the distance the threads overlap in a radial direction. The length of thread engagement is one of the key strength aspects, which the designer may be able to control.

*Thread Series*

Three standard thread series in the Unified screw thread system are highly important for fasteners: UNC (coarse), UNF (fine), and 8-UN (8 thread). A chart listing the standards sizes and thread pitches with their respective thread stress areas is located in the appendix.

Below are some of the aspects of fine and coarse threads.

*Fine Thread*

1. Since they have larger stress areas they are stronger in tension
2. Their larger minor diameters develop higher torsional and transverse shear strengths
3. They can tap better in thin-walled members
4. With their smaller helix angle, they permit closer adjustment accuracy

*Coarse Thread*

1. Stripping strengths are greater for the same length of engagement

2. Exhibit a better fatigue resistance behavior
3. Less tendency to cross thread
4. Assemble and disassemble more quickly and easily
5. Tap better into brittle materials.
6. Larger thread allowances allow for thicker coatings and platings

Numerous arguments have been made for using both the fine and coarse thread series; however, with the increase in automated assembly processes, bias towards the coarse thread series has developed.

#### *UNR Threads*

The UNR thread is modified version of a standard UN thread. The single difference is a mandatory root radius with limits of 0.108 to 0.144 times the thread pitch. When first introduced, it was necessary to specify UNR (rounded root) threads. Today, all fasteners that are roll threaded should have a UNR thread. This is because the thread rolling dies with the rounded crests are now the standard.

#### *UNJ Thread*

The UNJ thread is a thread form having root radius limits of 0.150 to 0.180 times the thread pitch. With these enlarged radii, minor diameters of external thread increase and intrude beyond the basic profile of the UN and UNR thread forms. Consequently, to offset the possibility of interference between mating threads, the minor diameters of the UNJ internal threads had to be increased. 3A/3B thread tolerances are the standard for UNJ threads. UNJ threads are now the standard for aerospace fasteners and have some usage in highly specialized industrial applications

### **Strength of Threads**

Two fundamentals must be considered when designing a threaded connection.

1. Ensure that these threaded fasteners were manufactured to some current ASTM, ANSI, U.S. Government or other trusted standard.
2. Design bolts to break in tension prior to the female and/or male threads stripping. A broken bolt is an obvious failure. It's loose. However, when the threads strip prior to the bolt breaking, we may not notice the failure until after the fastener is put into service.

As was shown on page 1, the strength of bolts loaded in tension can be easily determined by the ultimate tensile strength. To determine the amount of force required to break a bolt, we multiply its ultimate tensile strength by its tensile stress area,  $A_s$ . Determining the strength of the threads is more complicated. Since the male threads pull past the female threads, or vice-versa, the threads fail in shear and not in tension. Therefore, the stripping strength depends on the shear strength of the nut and bolt materials.

To determine the force required to strip the threads we must multiply the shear strength by the cross sectional area, which must be sheared. Determining the cross sectional area in which the shear occurs is a problem. Here are three possible alternatives for the failure.

1. The nut material is stronger than the bolt material. In this example, the nut threads will wipe out the bolt threads. The failure will occur at the root of the bolt threads.
2. The bolt material is stronger than the nut material. With this example, the bolt threads will tear out the nut threads. The failure will occur at the root of the nut threads.
3. The nut and bolt are the same material. With this example, both threads will strip simultaneously. This failure will occur at the pitch line.

The tensile strength of most fasteners is a common specification whereas shear strength is not. In order to avoid shearing in the threads, we must insure that the length of engagement between the bolt and nut, or tapped hole, is long enough to provide adequate cross-sectional thread area. The typical failure for both alternative #1 and #2 would be a tensile failure of the bolt provided proper engagement.

With conventional steel nut and bolt materials, a length of engagement of about one nominal diameter of the bolt is typical. A longer thread length engagement will be needed when dealing with tapped holes in soft material.

One point must be emphasized: the nut or tapped hole should support more load than the bolt. When using nuts this is simple to follow. First you want to pick a nut specification that is recognized by the bolt specification (ASTM A193-ASTM A194, SAE J429-SAE J995, etc.). Second, you want to pick a nut whose proof load is greater than or equal to the tensile strength of the bolt. A nut compatibility table is provided in the appendix.

#### *Thread Production*

There are basically two methods of producing threads: cut and rolled. The shank on a blank that is to be cut thread will be full-size from the fillet under the head to the end of the bolt. Cut threading involves removing the material from a bolt blank to produce the thread with a cutting die or lathe. By doing this, the grain flow of the material is interrupted.

Rolled threads are formed by rolling a reduced diameter (approximately equal to the pitch diameter) portion of the shank between dies. On external threads, the dies apply pressure compressing the material forming the minor diameter and allowing the material to expand to form the major diameter (imagine squeezing a balloon with your hand: you compress with the fingers to form the valley, while allowing part of the balloon to expand between your fingers). Rolling of the thread has several advantages: more accurate and uniform thread dimension, smoother thread surface, and generally greater thread strength (particularly fatigue and shear strength).

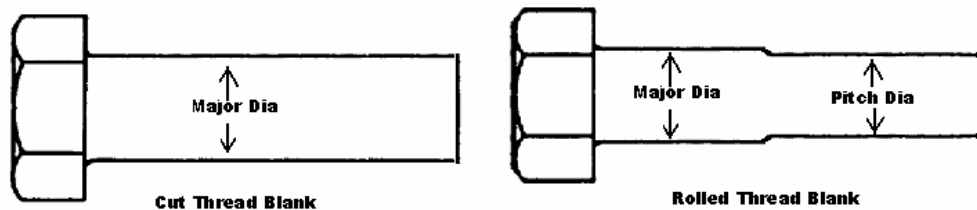

#### **Platings and Coatings**

Most of the threaded fasteners used today are coated with some kind of material as a final step in the manufacturing process. Many are electroplated, others are hot-dipped or mechanical galvanized, painted or furnished with some other type of supplementary finish. Fasteners are coated for four primary reasons:

1. for appearance
2. fight corrosion
3. reduce friction
4. reduce scatter in the amount of preload achieved for a given torque.

There are three basic ways in which coatings can fight corrosion.

1. They can provide a barrier protection. This simply means that they erect a barrier, which isolates the bolt from the corrosive environment, thereby breaking the metallic circuit, which connects the anode to the cathode.
2. They can provide a “galvanic” or sacrificial protection. To cause problems, a metallic connection must be made between the anode and the cathode and an electrolyte. In this type of reaction it is always the anode, which will get attacked, so if we make the fastener the cathode, we can protect it.
3. They can fight corrosion by “passivation” or “inhibition”, which slows down the corrosion and makes the battery connection less effective. This is common with the use of nickel in stainless steel bolts, which are said to be passivated. A thin oxide layer is formed on the surface of the bolt. The oxide film, according to theory, makes it more difficult for the metal to give off electrons.

There are several means of applying coatings onto fasteners.

#### *Electroplating*

Electroplating is the most common way to apply an inorganic coating. Many different metals, or combination of metals, can be plated onto fasteners by using a chemical reaction. Electroplating is carried out in a fluid bath, which contains a chemical compound of the metal to be deposited. The parts to be

plated are immersed in the bath and an electrical current is produced causing the plating material to precipitate out and deposit onto the fastener.

Cadmium and zinc are the two most popular electro-deposited coatings. To a lesser degree, aluminum, copper, tin, nickel, chromium, lead and silver are also used. Zinc, cadmium and aluminum are preferred due to their relationship with carbon steel, stainless steel, and most other nonferrous metals used in fastener applications in the Galvanic Series. The plating material is less noble than the fastener. In an electrochemical reaction, the plating material will corrode, and the fastener material will remain protected.

Zinc is a relatively inexpensive fastener coating and can be applied in a broad range of thicknesses. Zinc fasteners, however, are less lubricious than cadmium, and require more tightening torque to develop a given preload. Zinc also tends to increase the scatter in the torque-tension relationship.

Another disadvantage is that the zinc coating will develop a dull white corrosion known as “white rust” unless a supplemental clear or colored chromate is added. This added coating seals the surface from early tarnishing and reinforces the fastener’s resistance to a corrosive attack. The chromate film is offered in a wide variety of colors: clear and yellow are typical. Often you will zinc coating referred to as a zinc dichromate finish.

Cadmium has long been the most popular plating material. The cadmium plating provides excellent corrosion protection against salt water and other kinds of salts. This type of plating was seemingly inexpensive and provides a reasonably low and fairly consistent coefficient of friction. The cadmium plating does not tarnish or fade.

One main problem with cadmium is that a cyanide rinse is used during the plating process. This rinse is dangerous and can create environmental problems. Most industrialized countries have completely banned the use of cadmium plating. Like most other countries, the United States originally banned the use of cadmium plating. However, the U.S. recently removed this ban. Instead, strict governmental regulations have been implemented that define the disposal of the rinse. These regulations add an extreme cost to the plating process and have discouraged many from choosing cadmium plating.

#### *Hot-Dip Coatings*

Fasteners can be coated by dipping them in baths of molten metal. Fasteners hot-dipped in aluminum are said to have been “aluminized” and zinc-coated fasteners to have been galvanized. Hot dipping is an inexpensive means of protecting fasteners and is widely used. Hot dipping provides a thicker coating than does electroplating and, as a result, can give the fastener more protection against corrosion. A problem associated with the hot-dipping process is the difficulty in controlling the coating thickness throughout the fastener. ASTM A153 is a common specification for hot-dipped coatings on fasteners.

#### *Mechanical Plating*

Small particles of cadmium, zinc or other metals can be cold-welded onto the fastener surface by mechanical energy. Glass beads are air blasted to slam the particles against the base metal. The coating thickness produced with mechanical galvanizing are much more uniform than hot-dip galvanizing. The major advantage of the mechanical plating process is not exposing the fastener to hydrogen embrittlement. Another advantage is that a wide variety of metals can be applied by using a mixture of particles. A mixture of aluminum and zinc may be used to provide the durability of the aluminum plus the galvanic protection of zinc. A phosphate coating can be added to the aluminum zinc to improve lubricity.

#### *Dimensional Effects of Plating*

On cylindrical surfaces, the effect of plating (or coating) is to change the diameter by twice the coating thickness (one coating thickness on each side of the cylinder). Due to the fact the coating thickness is measured perpendicular to the coated surface, while the pitch thread axis is measured perpendicular to the thread axis, the effect on the pitch diameter of a 60° standard thread is a change of four times the coating thickness on the flank. The following illustration demonstrates this.



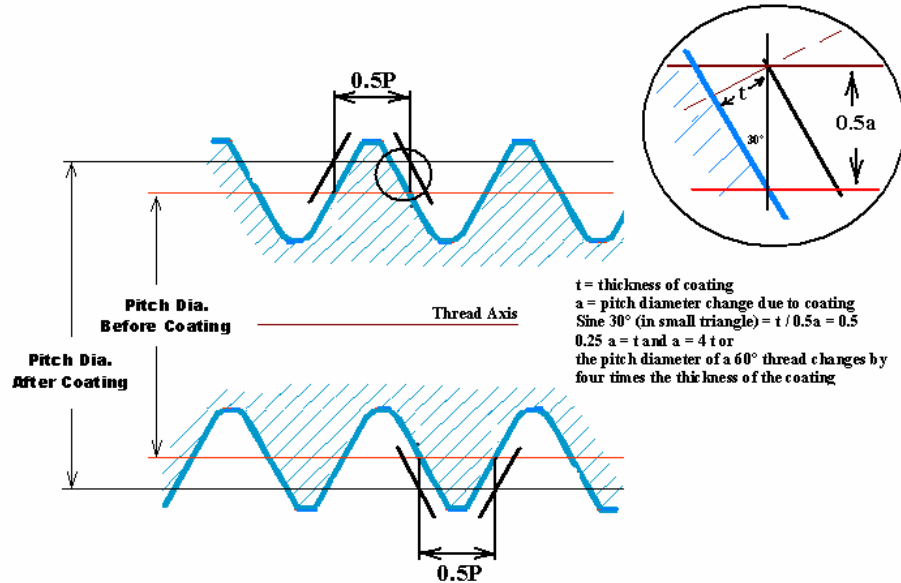

Take for example the illustration from page 11 with the  $\frac{3}{4}$ -10 2A-thread fit. The maximum pitch diameter was 0.6832-inch before coating. By applying a coating with a thickness of 0.0003, we increase our pitch diameter by 4 times 0.0003 or 0.0012-inch. Our maximum pitch diameter could now be 0.6844-inch.

## Corrosion

**Table 1 Galvanic Series of Metals and Alloys**

<b>+ Corroded End (anodic or increasingly active)</b>
Magnesium and magnesium alloys
Zinc
Aluminum 1100
Cadmium
Aluminum 2024-T4
Iron and steel
304 Stainless steel (active)
316 Stainless steel (active)
Lead
Tin
Nickel (active)
Inconel nickel-chromium alloy (active)
Hastelloy Alloy C (active)
Brasses (Cu-Zn alloys)
Copper
Bronzes (Cu-Sn alloys)
Copper-nickel alloys
Monel (70Ni-30Cu)
Nickel (passive)
Inconel (80Ni-13Cr-7Fe) (passive)
304 Stainless steel (passive)
316 Stainless steel (passive)
Hastelloy Alloy C (passive)
Silver
Titanium
Graphite
Gold
Platinum
<b>- Protected End (cathodic or increasingly inert)</b>

For many applications, the problems of corrosion pose an extreme concern in design. One of the first questions a designer must address when analyzing a fastener application is what is the service environment; is there a possibility the fastener will be subject to a corrosive attack? It is important to understand that there are several different types of corrosion including galvanic corrosion, concentration-cell corrosion, stress corrosion, fretting corrosion, pitting and oxidation. Probably the most common form of corrosion is rust associated with steel structures and fasteners, although the effects of corrosive attack can be seen in many other structural materials.

Corrosion can be thought of as an electro-chemical action in which one metal is changed into a chemical, or simply, eaten away. When two metals are in contact with each other in the presence of some electrolyte such as hydrochloric acid, the less active metal, as seen in the Galvanic Series, will act as the cathode and attract electrons from the anode. The anode is the material, which is corroded.

A simple means of visualizing what is occurring is to consider the action of a battery. If two metals are immersed in an acid, a saline or an alkaline solution, a battery is formed. This battery produces a flow of electrons between the two metals. This flow of electrons continues as long as the metals exist, the solution remains acidic, saline or alkaline, and as long as a conductive path connects the two metals.

In the case of galvanic corrosion, the combination of two dissimilar metals with an electrolyte is all that is needed to form a reaction. The use of dissimilar metals in structural design is not rare, especially where

fasteners are a different material from the structure being joined. The necessary ingredient to induce corrosion, the electrolyte, may be present in the form of rain, dew, snow, high humidity, ocean salt spray, or even air pollution.

All metals have some kind of electrical potential. The Galvanic Series of Metals and Alloys provide a realistic and practical ranking. Table 1 represents the relative reactivities of a number of metals and commercial alloys in seawater. The alloys near the bottom are cathodic and unreactive, whereas those at the top are most anodic. The various metals within grouped together are reasonably compatible when used together; those in different groups may cause a corrosion problem. Some metals, especially those with significant contents of nickel and chromium, are included in the table in both their active and passive conditions. Passivation, surface cleaning and sealing, lowers the metal's electrical potential and improves its corrosion behavior. As the series suggests, steel and aluminum are relatively compatible, but if brass and steel contact, the steel, as the anode, will corrode. A chart is provided in the appendix that may be used to aid with fastener selection based on galvanic reaction.

The following figure illustrates the effects of the galvanic series. A brass plate is connected to an aluminum plate using a 304 passivated stainless steel fastener. If no protection is used over the contacting surface, galvanic corrosion will occur. The brass and aluminum plates will both corrode where they touch the fastener. The aluminum plate will corrode more heavily due it being more anodic than the brass. The aluminum plate will corrode where its exposed surface is in contact with the brass plate.

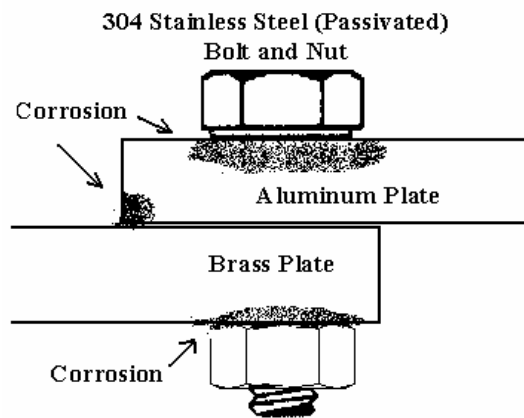

**Galvanic Corrosion Effects**

Concentration-cell corrosion and pitting are similar types of corrosion in that only one metal and an electrolyte are sufficient to set up an attack system. As corrosion progresses, a differential in concentration of oxygen at the metal surface and in the electrolyte produces a highly effective localized battery with resultant corrosion and metal attack.

Other corrosion systems can be equally severe. Common to all systems is that the corrosion is encountered normally after the structure is put into service. Corrosion protection at design inception should be a key objective of the joint design.

One of the first steps is to design or identify the specific anticipated corrosion exposure in order to control or minimize its consequences in service. An attempt should be made to select fastener materials, which are compatible with the structure being joined. One possible consideration is a protective coating or finish for the fastener to provide protection. Supplemental coatings or finishes may provide additional protection for the entire joint.

**Hydrogen embrittlement** is generally associated with high-strength fasteners made of carbon and alloy steels. Although, even precipitated hardened stainless steels, titanium and aluminum alloys can be

vulnerable. The fasteners or parts under stress can fail suddenly without any warning. There are many different theories on the exact cause. The following is our comprehension on the subject:

Hydrogen is the most common element in the world. Many acidic and oxidation reactions with steel will liberate hydrogen with the quantity released depending on the specific chemical reaction.

Hydrogen is released by the reaction of any active metal with an acid. Typical examples of this are HCl (hydrochloric acid) or H<sub>2</sub>SO<sub>4</sub> (sulfuric acid) with steel.

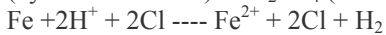

Even high-pressure steam can liberate hydrogen when in contact with steel.

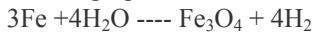

Internal hydrogen embrittlement (the more common form of hydrogen embrittlement) can occur any time atomic hydrogen is absorbed into the fastener from any chemical process before exposure to an externally applied stress.

One of the most common means of introducing hydrogen is during various electroplating operations. Typically the hydrogen is absorbed during acid cleaning or descaling process and then is trapped by the plating. If the fasteners are not baked in a subsequent operation, hydrogen will remain trapped by the plating. When tension is applied to the fastener, the hydrogen will tend to migrate to points of stress concentration (under the head of the fastener, first engaged thread, etc.) The pressure created by the hydrogen creates and/or extends a crack. The crack grows under subsequent stress cycles until the bolt breaks.

Unfortunately this is only one of several models of hydrogen embrittlement. As mentioned previously, any chemical process that introduces hydrogen into the material can lead to embrittlement. Other sources of hydrogen causing embrittlement have been encountered in the melting of steel, processing parts or even welding. The main point about internal hydrogen embrittlement is that the absorption of hydrogen by the base metal prior to the applied stress.

Another hydrogen embrittlement concern is environmental hydrogen embrittlement. Environmental hydrogen embrittlement is generally caused by hydrogen introduced into the steel from the environment after exposure to the externally applied stress. The hydrogen can come from a number of external sources including a by-product of general corrosion, or as demonstrated earlier, a by-product of a common reaction.

Stress corrosion (also referred to as environmental hydrogen embrittlement) represents a particular condition where cracks are induced and propagated under combined effects of stress and corrosion environments. It is said to be the least understood corrosion related phenomenon, but by far the most dangerous. Structures or components with high stress concentrations, such as threaded fasteners, are susceptible to this type of attack when under load. The initial corrosion may occur at a point of high stress contributing to crack initiation, which can be either, intergranular or transgranular. Continued exposure to the corrosion environment will propagate the crack, resulting in serious, and possibly catastrophic failure.

Stress corrosion, along with other material failure modes such as stress embrittlement, environmental hydrogen embrittlement and hydrogen assisted stress corrosion, differ from internal hydrogen embrittlement because they are all related to the service environment. These failures occur after installation due to hydrogen being introduced by a chemical reaction induced by the service environment.

There are three main ways in which hydrogen embrittlement can be fought.

- **Hardness:** Harder, stronger materials are more susceptible to failure than weaker, softer ones. In general, if the hardness of the fastener is less than 35 HRC, you'll probably encounter little difficulty. If, however, the fastener has hardness above 40 HRC, problems are more likely to occur.

- Coating: Use a coating process that does not introduce hydrogen into the material (particularly those free from acids used for cleaning). If electroplating is still desired, ensure to use the proper plating procedures and baking the fasteners correctly based on the hardness of the fastener.
- Environment: Your application environment should play a crucial role in the fastener material selection. The potential for hydrogen embrittlement cracking for even fasteners below HRC 35 is accelerated if the fastener is acting as the cathode in a galvanic couple. Caustic or sour environments may require much lower hardness levels to lower the susceptibility to hydrogen embrittlement.

### **High Temperature Effects**

Most fastener materials are temperature sensitive. This means that their properties are influenced by a change in temperature. A metallic fastener's strength properties decline with an elevation in temperature. Once the temperature increases significantly, other problems also begin to occur. Some of these problems include, but are not limited to, a breakdown in the coatings, high temperature corrosion, differential thermal expansion coefficients between the fastener and the joint and creep and stress relaxation.

The strength of most fasteners will decrease as temperatures rise. Any type of plating, or coating will also alter the results; for example, zinc plated fasteners are usually not recommended to be used above a temperature of 250°F.

One of the most celebrated examples of temperature effects on bolts is with Grade 8.2 bolts. At room temperatures, Grade 8.2 and SAE J429 Grade 8 bolts have similar properties. But, Grade 8.2 bolts are made of low carbon boron steel. The Grade 8 fastener is a medium carbon alloy steel. The boron steel has a lower tempering temperature (minimum 650°F compared to the 800°F for the Grade 8) and is not intended for use in higher temperatures.

Every bolting material has a temperature above which it would be unsafe to use. Often times this is referred to as the fasteners high temperature service limit. Although we saw that the fastener loses strength as the temperature increases, the service limit is usually determined by an occurrence known as stress relaxation.

A fastener is tightened in the joint. This action places the bolt under significant stress. The length of the bolt does not increase. The joint and the nut will determine the length. Once exposed to a higher temperature, the bolt begins to relieve itself of a significant amount of the stress. Since the stress and the preload are related, this implies that the clamping force with which the bolt holds the joint together will be significantly reduced.

One of the most problematic temperature effects that must be taken into account when designing a joint is differential thermal expansion between the bolt and joint members. As the temperature rises, all bolt and joint materials expand, but not all at the same rate.

As an example, aluminum will expand about twice as much as some carbon steel fasteners. If using a SAE J429 Grade 8 fastener to clamp an aluminum joint, we would expect to see a significant increase in the tension of the bolts, which would increase the clamping force as the temperature increases. This reaction could damage the joint or gasket material or even break the bolt. If we were using bolts that would expand more than the joint, we could lose our preload and clamping force.

It should be recognized that differential expansion problems could occur even if the fastener and the joint are made of the same material. If the bolt and the joint heat up at different rates, the corresponding thermal expansion will also cause the bolt and the joint to expand differently.

There are various other temperature-related effects, which must be considered when designing a bolted joint. Two of the more common occurrences that are very closely related are creep and stress relaxation.

If a constant load is applied to a fastener and we raise the service temperature and the temperature places the bolt in its "creep range," the bolt will begin to stretch even if the load is well within the fastener's

mechanical limits. Eventually, the bolt may stretch to a point where it may not be able to support the load and will fail. Creep is defined as the slow increase in length of a material under a constant, heavy load.

Stress relaxation is very similar. However, we are now dealing with the steady loss of stress in a loaded part with fixed dimensions. We place a significant amount of stress on a bolt when we tighten it in the joint. If exposed to a high temperature, the bolt begins to relieve itself of some of the stress and we can lose our preload.

The behavior of the bolted joint will depend, to a large extent, on the clamping force on the joint in service. This may be significantly different than the clamping force created during assembly. Thermal effects can change the initial clamping force significantly. Therefore, these effects should be a real consideration when originally designing the joint.

Usually we would like to employ the highest clamping force the parts can withstand. This may compensate for some of the anticipated losses. There are, however, several limitations to the assembly preload. Too much force on the joint may damage joint members and gaskets or encourage stress cracking.

If more preload is not a possibility, other considerations may be made. You can alter the stiffness ratios between the bolt and the joint. You may also look at using similar materials for bolt and joint members.

### Joint Design

Loads on bolted joints come in an array of types, which significantly vary their effects, on the joint, not only in the way they are loaded, but also on how the joint responds to the load. Some of the loads include tensile, shear and bending. The bolted joint takes its name from the external load as illustrated in the following figures.

#### *Tensile Loads*

A tension joint, as illustrated below, sees loads that try to pull the joint apart. The forces on the joint and the bolts are approximately parallel to the axes of the bolts. All tensile forces try to stretch and/or separate the joint. The tension load, no matter how small, will add to the stress in the bolt and/or partially relieve the joint.

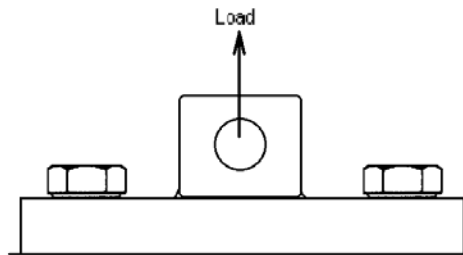

**Tension Joint**

The bolts in a tension joint must act like clamps. The assembling and tightening of the bolt and nut produces a tensile prestress in the fastener, which is approximately equal to the compressive stress introduced in the joint material. The behavior and life of the joint depends on how tightly the bolts clamp the joint and how long they can maintain their preload.

With a tension joint, the proper amount of tension in the bolts is vital. With too little clamping force, the joint may loosen. Bolt fatigue may also be a problem associated with too little clamping force in a tension joint. Too much clamping force can also cause severe problems. By over-tightening the bolt, we may exceed the proofload of the bolt. Even if the bolt does not fail during assembly, it may later break under the external tensile load. Over-tightening of the bolt can also encourage the advancement of hydrogen embrittlement or stress corrosion cracking. The joint members can also be damaged or warp from too much clamp force.

The clamping force created in the joint when the bolt is tightened stretches the bolt similar to a spring. A similar analysis can be made for the joint, except it is compressed like a spring during assembly. These springs act as energy storage devices. The clamping force will only remain as long as the bolts are stretched. Any applied service load or condition, which relaxes the bolt or reduces the clamping force, will release some of the spring's energy. This will increase the chances that the joint may loosen or that the bolts may fail.

A joint diagram may help illustrate what happens as we apply our preload and the effects of external loads. As the bolt is tightened, the bolt elongates ( $\Delta B$ ). Due to the internal forces resisting the elongation, a tension force or preload is produced ( $F_p$ ). Notice the constant slope or straight-line relationship between the force and elongation. Remember from page 1 that our stress-strain curve (which is basically applied force-elongation) will be constant, or straight until we begin to yield our fastener.

The reaction force is the clamp load of the joint being compressed.  $\Delta J$  represents the amount that the joint has compressed. As is illustrated,  $\Delta J$  is smaller than  $\Delta B$ . These values represent the stiffness of each component. Often you will see the stiffness of a bolt of only 1/3 to 1/5 to that of the joint. We'll elaborate more on this once we apply an external load. For now our bolt tension is equivalent to the preload, which is equivalent to the joint compression. As for now the tension force on the bolt ( $F_b$ ) is equal to the compression force on the joint ( $F_j$ ), which is equivalent to the preload ( $F_p$ ).

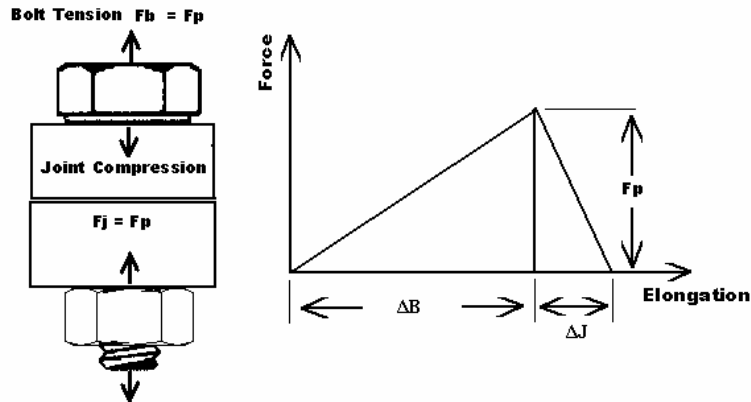

If we were to apply an external tensile force ( $F$ ) to our fastened joint it will reduce some of the clamp force ( $\Delta F_j$ ) caused by the bolts preload and apply an additional force onto the bolt ( $\Delta F_b$ ). This is shown in the following diagram. Since the bolt and joint have different a stiffness,  $\Delta F_b$  will not be the same as  $\Delta F_j$ . As is also demonstrated, the bolt will further elongate (New  $\Delta B$ ), and we'll have a reduction in the compression of the joint (New  $\Delta J$ ). The increase in length is equal to the increase in thickness of the joint.

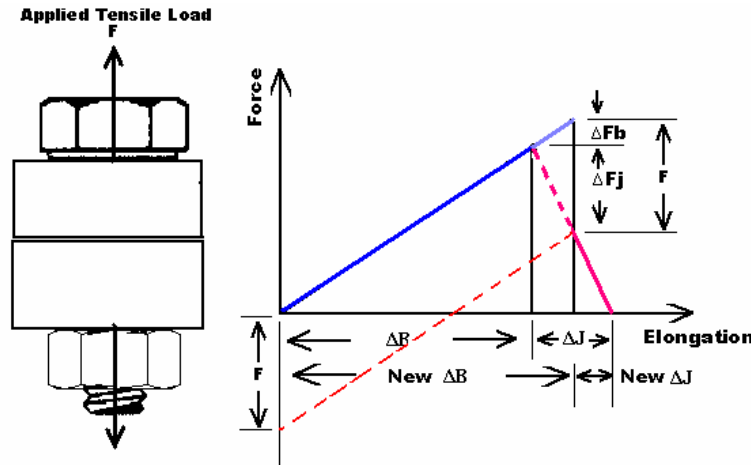

If the applied load ( $F$ ) is allowed to increase, the clamp force acting on the joint will continue to decrease until a point where the joint would be fully unloaded ( $\Delta J = 0$ ). Any further increase in the applied force will result in a gap forming between the plates comprising the joint and the bolt sustaining all of the additional force. This is illustrated in the joint diagram below. In this case, the bolt or bolts are almost always subjected to non-linear loadings from bending and shear forces acting. This usually quickly leads to bolt failure.

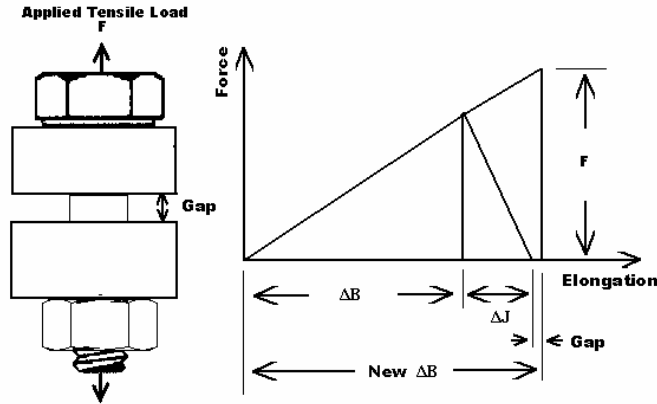

The following diagrams illustrate the importance of the stiffness ratio of the bolt and joint in determining how much of the applied external load is seen by the fastener. Figure A shows a bolt with nearly the same stiffness as the joint. As can be seen the fastener is nearly absorbing an equal amount of the applied load. Figure B shows a softer (or a more “springy”) fastener with a stiff joint. For this example, the joint is absorbing more of the load.

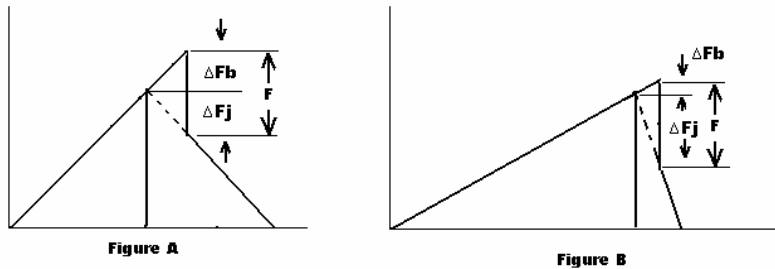

In the following illustration a percentage of the applied load ( $F$ ) and the preload has resulted in the bolt yielding. We are now in the plastic range of the fastener material, and our curve is now nonlinear. Failure is very likely. Even if failure does not immediately occur if the applied load was removed the preload will decrease.

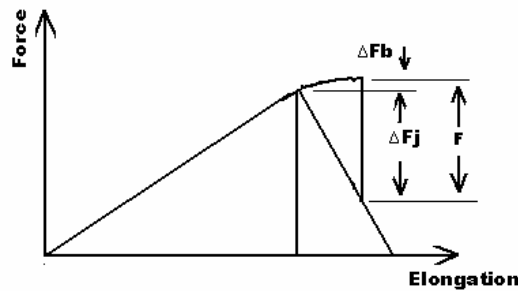

These are only a few of the possibilities to demonstrate with joint diagrams. There are a number of other “real-life” factors, which may be impossible to predict, that allow the spring energy to be lost in the assembled joint. These factors include, but are not limited to different points of loading, creep, external loads, stress relaxation (in some instances a relaxation of 10% to 20% can be common), temperature, differential thermal expansion, and vibration.

The overriding concern with the tension joint is that it specifically relies on the unreliable bolt tension or preload. If the clamping force is not correct, the joint can, and often does, fail in several ways; either by bolt fatigue, vibration loosening, stress corrosion cracking or hydrogen embrittlement.

#### *Shear Loads*

A shear joint is one in which the applied loading is at right angles to the fastener axis or across the bolt shank. Joint failure occurs when the joint members are slipped sideways past each other, and eventually cut the fastener. The following figure shows a simple single shear joint.

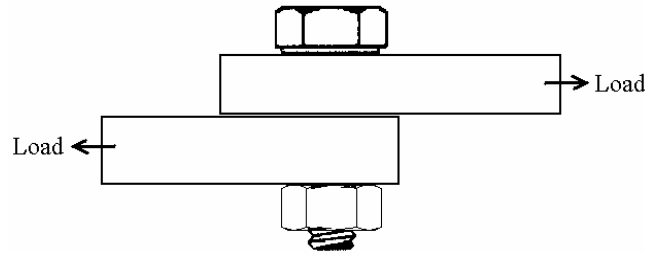

**Shear Joint**

With some shear joints; the ultimate joint strength depends only upon the shear strength of the bolts or the joint member. This type of joint is referred to as a “bearing type” joint. The amount of tension created in the bolts during assembly is relatively unimportant as long as the fastener is retained in the assembly. The joint member is allowed to slip until the fasteners come into “bearing” and prevents further slip. The fastener in this assembly is basically used as a pin.

Other types of shear joints depend on their initial clamp load as a resistance to slip. This type of joint requires that a frictional force be created between the joint members when the bolts are tightened. The shear forces have to overcome the friction developed by the clamp load, which in most cases will be far more than the actual “shear strength” of the fastener itself. This type of joint is common in the structural steel construction industry and may be referred to as a “friction-type” or “slip-critical” joint.

#### *Bending Loads*

Unfortunately, not all joints are always loaded in pure shear or pure tension. Some applications subject the joint to a bending force, which results in a combined tension, and shear load acting simultaneously on the fastener. With the use of a shear-tension load interaction curve, design limits can be established for fasteners with known ultimate tensile and shear strengths. However, even with a valid interaction curve for design support, extreme caution must be taken when working with a joint subjected to bending.

### **Tension Control in Bolted Joints**

Threaded fasteners can do a good job of holding things together only when they are properly tightened. The fastener to ensure the proper performance of the joint must produce an appropriate tension. To this day a simple, inexpensive, and effective way to determine if a fastener is properly tightened has not been found. Through the years, satisfactory ways have been discovered, but they are neither simple nor inexpensive. In most situations we rely on less-than-perfect, but adequate traditional methods.

Were most joints not massively over-designed to accommodate inaccurate tightening, simple tightening procedures could prove catastrophic. Designers will specify more or larger bolts than needed in order to ensure that the joints are clamped together with the amount of force required. Fewer or smaller fasteners can be used when accurate control of bolt tension or preload is assured during assembly. For most applications the over-design of the joint has been far cheaper than controlling the assembly process.

Current trends for most applications, however, no longer favor the use of over-design. Increasing demands on cost, strength-to-weight ratios, product safety, product performance, and environmental concerns have



put pressure on designers, manufacturers and assemblers to do a better job with fewer, lighter parts. This trend has led to the discovery of more options in controlling design preload.

Whenever we tighten a bolt, a sequence of events takes place. By applying torque to the head, or the nut, we turn the fastener being torqued. This action stretches the bolt (similar to a spring) and creates a tension in the bolt. In most cases it is this tension or preload that we need to make a fastening. By controlling torque, turn, or stretch, we can control the buildup of tension. The closer we approach direct control of tension, the more accurate and expensive the method will be.

Some options for tension controls during assembly are: Torque Control, Torque and Turn Control, Stretch Control, and Direct Tension Control. These methods vary substantially in cost and accuracy.

### **Torque Control**

One of the most common terms involving fastener installation is “torque.” Often a torque value is specified for a given application, and with the use of a calibrated torque wrench, this torque value can be obtained. What must be realized, however, is that this reading does not indicate the bolt tension directly. Rather the torque reading is only an indirect indication of our desired tension.

A major question today is how much torque should be used to properly tighten a fastener. As simple as this question may seem, the answer depends on a variety of factors. It is estimated that roughly 90% of the input energy is lost in overcoming the mating friction under the head and between the thread or nut and its mating threads. Consequently only the remaining 10% of input energy is turned into bolt stretch. Bear in mind that this is an oversimplification of what may actually happen, since no consideration is given to the various forms of heat and strain energy introduced into the system.

In most situations there’s a relatively simple relationship between the torque applied to the bolt or nut and the tension created in it. Usually this relationship is linear. For such cases, the following equation is applicable:

$$\text{Torque} = K \times d \times F$$

where

K = Nut Factor (dimensionless)

d = Nominal Bolt Diameter (in., mm, etc.)

F = Bolt Tension (lbs., N)

F = 75% of bolt material proofload for standard bolts

F = 90% of bolt material proofload for special applications; such as structural bolts

Depending on inputs, the output torque will be given in inch-pounds, foot-pounds, or Newton-meters.

This equation implies a linear elastic zone of the torque verses angle-tightening curve. For most of our common fastening material we know the engineering values of the first two variables. The problem with this equation is with K.

The K, or nut factor, not to be confused with the frictional coefficient, can be thought of as a combination of three factors: K1, a geometric factor, K2, a thread friction related factor, and K3, an underhead friction related factor. While there are published tables for K, these will usually vary from publication to publication. For a more detailed analysis it is desirable and often necessary to determine this value experimentally by using a specially designed torque-tension load cell.

No two bolts respond exactly the same to a given torque. There are numerous “real world” complications. Things such things as dirt in a tapped hole, damaged threads, hole misalignment, and numerous other factors can absorb a large amount of the input torque and will result in a substantial loss in the preload which was determined. Some of the other common variables affecting the K factor may include, but not limited to:

- Hardness of all parts
- Types of materials
- Class of fit
- Plating, thickness and type

- Surface finishes on all parts
- Manufacturing processes, such as cut or rolled thread
- Washers, present or not
- Type of tool used for tightening
- Speed of tightening
- Which is torqued, the nut or the bolt
- The number of times the fastener was used
- The type, amount, condition, method of application, contamination, and temperature of any lubricant used

This is by no means a definitive list, and although the amount of and extent to which these factors are controlled is proportionate to the cost incurred, complete control would never be possible.

As you can see, each fastener, even from identical lots having relatively the same mechanical properties, will give you different torque values for the same preload. The K value can be thought of as summarization of anything and everything that affects the relationship between torque and preload. The following is a brief list of some estimated K factors that we have found in our laboratory. The list is intended to be used only as a suggestion and will actually vary per application.

**K Factors**

<b>Bolt Condition</b>	<b>K</b>
Non-plated, black finish	0.20 - 0.30
Zinc-plated	0.17 - 0.22
Lubricated	0.12 - 0.16
Cadmium-plated	0.11 - 0.15

The torque wrench is a relatively inexpensive means of giving a rough estimate of the bolt’s preload. For most practical applications, the torque wrench will provide the degree of accuracy desired. However, even perfect input torque can give a variation of preload by as much as 25 - 30 %. The following example will demonstrate some complications that can be involved in calculating torque.

**Example**

Hex Cap Screw 1/2 - 13 zinc plated grade 5

Using Torque = K x d x F

$$K = .20$$

$$d = 0.50 \text{ in.}$$

$$F = (75\% \text{ of the proof load}) = 0.75 \times 85,000 \text{ psi} \times 0.1419 \text{ sq.in} = 9045 \text{ lbs.}$$

$$T = (0.20) (0.5 \text{ in.}) (9045 \text{ lbs.})$$

$$T = 905 \text{ in.-lbs.} = 75 \text{ ft.-lbs.}$$

In the previous example, we considered K = 0.20. This is a common K factor for zinc-plated fasteners. We must now wonder what may have happened if the person installing the fastener would have excessively lubricated the bolt and installed it with the same torque. In such conditions, K may drop to a value of 0.10.

If  $T = K \times d \times F$ , then we can also determine the preload, F, in the same way.

$$F = T / (K \times d)$$

$$F = 905 \text{ in.-lbs.} / (0.10 \times 0.50 \text{ in.}) = 18,100 \text{ lbs.}$$

The value obtained for our preload, 18,100 lbs., would exceed the tensile strength of a 1/2 - 13 grade 5 bolt. More than likely the bolt in question would have failed. The exact opposite may have also happened resulting in a lower clamp load than may be required resulting in a field failure.

As a group of fasteners are tightened, those, which were tightened first, will tend to relax slightly. This is due to the creep and flow of heavily loaded thread and joint contact surfaces. Still more relaxation results

from the elastic interactions between a group of bolts as they are tightened one-by-one. The first bolts tightened partially pull the joint together. As we tighten the rest of the bolts the joint is further compressed, and the previously tightened bolts tend to relax and lose some of their preload. In some cases, this can virtually eliminate our bolt tension.

The main concern is to what extent must the fastener's preload be known. Numerous methods are available to the public, which, directly or indirectly, measure preload. If bolt tension is desired with a high degree of accuracy, the torque wrench is not the answer. The following, which will be discussed later, are highly accurate and expensive answers:

- measuring the actual elongation of the bolt
- hydraulic tensioners
- strain gages
- ultrasonics

### **Torque and Turn Control**

This method involves tightening the fastener to a low initial "snug tight" condition followed by a prescribed amount of nut turning to develop the required preload. The actual preload will depend not only on how far we turn the nut, but also on how much preload was established on the initial run-down, or "snug tightness" of the fastener.

The most general model of torque-turn analysis of a fastener consists of four distinct zones. The first, the run-down prevailing torque zone, is before the fastener head or nut contacts the bearing surface. The second, the alignment or snugging zone, is the area in which the fastener and the joint mating surfaces are drawn into alignment or a "snug" condition. The third is the elastic clamping range zone. Through this region the slope of the torque-angle curve is constant. The fourth, the post-yield zone, is where an inflection point begins.

The amount of turn required for run-down, the amount of preload created during snugging, and the bolt-to-joint stiffness ratios are all extremely difficult to predict or control. As a result, pure turn control is nearly useless. But the fact remains that the increase in a previously snugged bolt is directly proportional to the turn of the nut or head and is not affected by variations in friction. The combination of torque and turn is more accurate than either system alone.

Torque is used to determine roughly the amount of preload developed in a fastener during the snugging operation. The turn on the nut method is a more reliable measure of the further increase of tension of a previously "snugged" bolt. Experiments must first be done on a sample joint to determine the effect of turn on the joint and the fastener.

The torque and turn control method is more accurate than the torque alone method. The method, however, can only be used on joints whose response during assembly has previously been determined. The method is therefore more expensive. The method is also similar to the torque method in that it is also blind to things like creep relaxation and interactions between bolts if not tightened simultaneously. Accuracy is still affected by variables such as friction and stiffness ratios.

### **Stretch Control**

As we demonstrated earlier with the joint diagrams, when we apply torque to a bolt or nut, it turns, which stretches the bolt and creates a preload or tension in our fastener. This tension creates the clamping force, which holds our joint together. If the joint is considered to be critical, we will want to ensure that the proper amount of tension has been created in our joint upon tightening of the bolt, and that the tension remains in our fastener even after tightening of neighboring bolts and the relaxation of the fastener has occurred.

We can consider the bolt to be a stiff spring. As with a spring, an equation can be used to determine the change in length. The exact specifics of this analysis are far too extensive to be covered now. One of the major advantages to this method is that the bolt lubricity or bolt-to-joint stiffness ratios have no effect on

our calculations. Also, we can use the stretch control method to measure the bolt tension well after the tightening process is complete.

*There are several factors, which complicate this method:*

When we think of the bolt as a complex spring, the unthreaded body of the bolt is a relatively stiff spring and the threaded portion of the bolt can be considered to be a less stiff spring. When we load a bolt, the threaded portion of the bolt will tend to stretch more than the unthreaded shank of the bolt. Threads within the nut, or within a tapped hole, will also stretch less. The amount of engaged and unengaged thread stretch is directly affected by the fastener diameter. Calculations must be made using exact lengths of both the unthreaded portion of the bolt and the remaining length of the unengaged threaded portion of the bolt and also the diameter of the bolt.

To further complicate the idea, most authorities say that the head of a bolt also stretches slightly as we tighten a bolt. The head is considered to stretch about half as much as the same amount of body would stretch.

In order to use stretch control to estimate the tension in a bolt you must initially determine the amount of stretch each separate portion of the bolt contributes to the total stretch. You must also take into account the fact that the tension and stretch in the bolt head and the nut are not uniform throughout, but rather fall off from a maximum value at the joint surface to zero (no tension) at the outer ends of the fastener.

Other factors affect the relationship between stretch and tension in any given bolt. The basic elasticity of the bolt material may even vary from lot to lot of bolts. There are also variations in grip lengths and dimensional tolerances, which must be closely observed. The temperature of the bolt must be measured for precise tension determination.

A micrometer is the simplest tool used to measure bolt stretch. This tool can be used only if there is access to both ends of the bolt before and after installation. Also, since both ends will probably not be parallel, several measurements, at different points around the circumference, must be made and the average taken for the final measurement.

The point to remember with the use of the stretch control method is that it is a very precise tool available for evaluating bolt tension. We are trying to measure a change in the length of the bolt of only a few thousandths of an inch. Tremendous skill will be required to determine the exact length dimensions.

### **Direct Tension Control**

The previously mentioned methods tried to control the tightening process through torque, turn, and stretch. With each method, errors and uncertainties were discovered. Although some methods have proven to be more precise than others, none of them are able to control the tension developed in the fastener directly. However, the following methods will give us the tension developed directly in our fastener.

#### *Washer Control*

The least expensive and simplest tension control systems use direct tension indicating (DTI) washers. Several different types of DTI washers are available. The most common type of washer involves the use of “bumps” on one side of the washer. These “bumps” are flattened plastically as the fastener is tightened. A feeler gage is used to measure the gap developed by bumps. When the fastener has developed the appropriate tension, the feeler gage will no longer fit in the gap. Some of the newer types employ the use of silicone embedded under the “bumps”. The silicone squirts out once the “bumps” are compressed to indicate proper tension. The DTI washer has been used in the structural bolting industry for years and is now starting to carry over into other fields as well.

One thing to remember when using the DTI, or similar washers, is that they only can indicate the minimum tension required to close the gap. Added tension may be created in the bolts, but the washer would not be able to tell us how much. It should be also noted that this type of system cannot monitor or show us the

amount of bolt relaxation. Since the bumps on the washer deform plastically, they will not return to their original dimensions after relaxation.

A different kind of washer, the Belleville, involves a spring-like action. A stack of these washers are placed under the head or the nut. As the fastener is tightened, the height of the Belleville is reduced. The washers deform elastically, so they will continue to push upwards on the head or nut. Unless the washers are completely flattened, the clamping force developed in the joint can be determined.

#### *Alternative Design Bolts*

The alternative design bolts incorporate a design feature, which is intended to indirectly indicate tension. The most common type of this bolt is the “twist-off bolt” (tension control bolts). An assembly tool holds this bolt from the nut end. An inner spindle on the tool grips a spline section connected to the main portion of the bolt. An outer spindle on the tool turns the nut and tightens the fastener. When the design torque has been reached, the reaction forces on the spline snap it off.

This type of torque control system allows for a quick reference for inspecting if the fastener had been installed with a minimum amount of torque. The amount of tension actually developed in each fastener is not directly determined. There are other types of fasteners, some of highly elaborate designs, which work in a similar fashion.

#### *Hydraulic Tensioners*

A hydraulic tensioner is sometimes used to tighten large diameter bolts. An upper collar is threaded down onto the exposed section of thread above the nut. Hydraulic pressure is then used to pull upward on the bolt. The nut is then run down, freely, against the upper surface of the joint. When the hydraulic pressure is relieved, the nut continues to hold the majority of the tension developed.

#### *Ultrasonics*

An ultrasonic instrument can be used to measure bolt preload or tension. This instrument sends a brief burst of ultrasound through a bolt and measures the response time required for the sound to echo off the end and return to the transducer. As mentioned previously, the bolt will stretch as it is tightened. This increases the time required for the signal. Elaborate computer equipment, grip length, bolt material, and thread run-out lengths are needed to measure the change in transmittal time to determine bolt tension. This equipment has been available for many years, but due to the cost and quantity of components needed, is used in only a few applications.

### **The Reuse of Fasteners**

In a previous section, we discussed the proof load and yield point of the fasteners. It was stated that the proof load represents the usable strength range of the fastener. By definition, the proof load is an applied tensile load the fastener can support without permanent deformation. The bolt will return to its original shape once the load is removed. The bolt may be reused provided you are absolutely certain the bolt never exceeded this point and began to yield: a simple enough definition, but one that requires an extensive explanation.

As the fastened joint is put into use, it will encounter all types of various loads, including tension loads, shear loads, cyclic loads, prying loads and loads which may be a combination of these and other possibilities. Things like pressure changes in a pipeline, vibration from an engine or an impact of a hydraulic ram, may produce these loads. These external loads add to or subtract from the initial load of the fastener and in extreme cases may yield the fastener (refer back to the joint diagrams).

Heat will lower the yield value of the fastener. The yield strengths are determined at room temperature. ASTM A193 B7 has a yield strength of 75-105 ksi (75 ksi for sizes over 4 inches in diameter and 105 ksi for material in diameters up to 2-1/2 inches) at 70 degrees, and drops to approximately 53-74 ksi at approximately 800 degrees. So, if we install a B7 fastener at room temperature expecting each fastener to support a tensile load of 85 ksi, which would not yield the fastener of diameters 2-1/2 inches and smaller.

Now, if we were to introduce heat into our fastener application, the fastener would begin to yield at much lower load.

Was the fastener installed properly? This is one of the most difficult questions to answer (please refer to the section titled *Tension Control in a Bolted Joint*). This section discussed the difficulty of analyzing proper installation procedures. Extreme caution should always be used when relying on torque from a formula to indicate the tension induced. Torque is only an indirect indication of tension. Improper installation may yield the fastener.

One important factor to remember; typically you will not know whether or not the fastener has been yielded. Especially in critical situations, you should never reuse a fastener unless you are certain the fastener has never been yielded.

#### *Re-use of Fasteners and Torque*

The basic function of the nut is to produce and maintain the clamp load on the assembly. As the fastener elongates, it starts to apply a compressive load to the nut. The first engaged thread of the bolt experiences an enormous amount of tension from the entire body. Some of this load is transferred to the nut causing less tension in the bolt at the second engaged thread. Then, this thread transfers part of this load to the third thread, and so on. The threads of the bolt will stretch. At the same time, the compressive forces acting on the bearing surface of the nut squeeze the bottom threads of the nut together. Due to this deformation causing an uneven load distribution, the first few threads may plastically deform (yield).

The first few threads of the nut will support the majority of the load. Research has shown in some cases involving UNC threaded nuts, the first thread will have to support nearly 35% of the load. The second thread will support about 25% of the load, and the third thread about 18%.

To best allow the load to distribute to the mating threads, the nut is slightly softer than the bolt to allow its threads to distort a small amount to match the expanding contours of the bolt threads. If a nut were reused, there would no longer be a “perfect” thread match. This will create more friction between the threads during installation, which will significantly alter the installation torque.

On a recent demonstration with a ½-13 zinc plated SAE J429 Grade 5 hex cap screw and zinc plated SAE J995 Grade 5 hex nut we used an installation torque of 70 ft-lbs to obtain a clamp load of 9000 lbs (without any added lubrication). On the second installation, this torque had increased to 95 ft-lbs to obtain 9000 lbs. By the fourth installation, we required 145 ft-lbs to reach a clamp load of 9000 lbs.

### **Structural Bolts**

ASTM A325 & ASTM A490 are the two U.S. standard structural bolts.

If you look at the mechanical requirements listed in the appendix, you may notice that an ASTM A325 and SAE J429 Grade 5 appear identical. This also appears to be true for the ASTM A490 and the SAE J429 Grade 8.

So, can a SAE J429 Grade 5 be used when an ASTM A325 is specified? The answer is definitely not; this is also the case for substituting a Grade 8 when A490 is specified, and here are some reasons why:

1. A325 and A490 bolts are produced with a heavy hex head configuration; Grade 5 and 8 bolts are produced to standard hex cap screw configuration. This provides a wider bearing surface to distribute the load over a wider bearing surface.
2. The grip length (non-threaded portion of the body) on the A325 and A490 bolts is designed to be more (shorter thread lengths) than your standard hex bolt or hex cap screw. Remember that the weakest section of standard carbon steel fasteners is through the threaded region. Little design changes can be made to create a stronger tensile connection by changing the thread length, but how about shear. The following two diagrams demonstrate this difference:

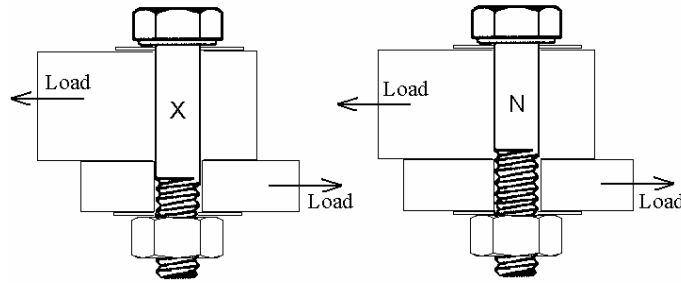

If both bolts are  $\frac{3}{4}$ -10 x 4, Bolt X has the shear plane acting through the body of the bolt (the intersection of your two sliding plate). Bolt N has its shear plane acting through the threaded portion. Let's say that we can estimate both fasteners to have an ultimate shear capacity of 72,000 PSI, just how many pounds would this be for each fastener? To determine this load in pounds, you must first calculate the area of material for each example.

Bolt X is just the cross sectional area of the body diameter: in the worst case scenario, the minimum body diameter is 0.729 inches: now by doing a little eighth grade geometry we can calculate the area of a circle with this diameter. Bolt A has a material cross sectional area of 0.417 square inches. Take 0.417 sq-in. and multiply by 72,000 PSI and you're left with nearly 30,000 pounds.

Bolt N you need to calculate the threaded shear area, which is 0.302 sq-in. Now take this and multiply by the same 72,000 PSI and you're left with approximately 21,740 pounds.

The above example demonstrated an improvement of 8260 pounds by using the same strength fastener by just ensuring the shear load was applied to the body of the bolt. Oftentimes, drawings and blueprints indicate the structural bolt with an X or an N designation. The X indicates that the threads are excluded from the shear plane. The N indicates that the threads may be included in the shear plane.

A recent test was designed to determine the affect on the bolted connection when varying the levels of pretension. The test included A325, A490, Grade 5 and Grade 8 fasteners. Strain gauges were mounted to the test apparatus' that monitored the bolt forces during various types of applied loads. The bolts were fully tightened, snug tightened or finger tightened.

The experiment found that when using grade 5 and grade 8 bolts in place of A325 and A490 respectively, lead to larger deformations at failure. The grade 5 and grade 8's have longer thread length than their respective A325 and A490 bolts. The plastic behavior is distributed over more the fastener, making them more ductile.

ASTM A325 bolts are available in diameters from  $\frac{1}{2}$  to 1-1/2 inch diameters (for diameters greater than 1-1/2, ASTM A449 specifications should be examined) with a minimum tensile strength of 120,000 PSI for diameters one inch and less and 105,000 PSI for sizes over one inch to 1-1/2, and in two types. Type 1 is a medium carbon steel and can be galvanized Type 3 is a weathering steel that offers atmospheric corrosion resistance similar to that of ASTM A242 or A588 steels.

ASTM A490 bolts are available in diameters from  $\frac{1}{2}$  to 1-1/2 inch diameters with a minimum tensile strength of 150,000 psi for all diameters, and in two types. Type 1 is alloy steel. Type 3 is weathering steel that offers atmospheric corrosion resistance similar to that of ASTM A242 or A588 steels. **ASTM A490 bolts should not be galvanized.**

Structural bolts are specifically designed for the use with nuts in the connection of structural members. The nuts for structural connections shall conform to ASTM A563 or ASTM A194. A chart is provided in the appendix to select the proper grade nut that must be used. The washers used for structural

connections shall meet ASTM F436 specifications. This specification covers both flat circular and beveled washers.

According to the American Institute of Steel Construction (AISC), for structural applications, there are generally three types of connections that the bolt is used; snug tightened bearing, fully tensioned bearing and slip critical connections. In accordance with the AISC, bolts used in fully tensioned bearing or slip-critical connections are required to be installed to within 70% of the minimum tensile strength of the bolt.

There are four methods of installation procedures recognized by the AISC to achieve the tension required for the fully tensioned bearing or the slip critical connection; (1) turn-of-nut method (2) alternative design bolt method (tension control bolts) (3) direct tension indicating method (DTI) (4) calibrated wrench method. It is not valid to use published values based on a torque tension relationship. In other words, YOU CAN NOT USE TORQUE FROM A FORMULA. The calibrated wrench method is only valid if installation procedures are calibrated on a daily basis by tightening three representative fastener assemblies for each lot diameter, length and grade with nuts from each lot, diameter and grade and with a hardened washer from the washers being used placed under the element being turned in tightening in a device (Skidmore-Wilhelm) capable of measuring actual bolt tension.

### **Standards**

The expansion of global trade and the increasing rapid development of technology in many sectors have and will continue to present major underlying hazards in today's market. Now more than ever, there is a need for standards and standardization. By definition, standards are documented agreements containing technical specifications or other precise criteria to be used consistently as rules, guidelines or definitions of characteristics to ensure that material, products, processes and services are fit for their purpose. There are several distinct international and regional standard organizations. The following will give a brief description of some the larger organizations:

#### *ANSI (American National Standard Institute)*

Founded in 1918, ANSI has served in its capacity as administrator and coordinator of the United States private sector voluntary standardization system. ANSI promotes the use of U.S. standards internationally, advocates U.S. policy and technical positions in international and regional standards organizations and encourages the adoption of internal standards as national standards where these meet the needs of the user community. ANSI does not itself develop American National Standards; rather it facilitates development by establishing consensus among the ANSI member associations such as ASTM, SAE, ASME, etc.

#### *ASTM (The American Society for Testing and Materials)*

ASTM is a scientific and technical organization formed for "the development of standards on characteristics and performance of materials, products, systems, and services; and the promotion of related knowledge." Through technical committees, ASTM publishes standard test methods, specifications, practices, guides, classifications and terminology. ASTM standards cover metals, paints, plastics, textiles, petroleum, construction, the environment, medical services, electronics, fasteners and many other areas.

#### *ASME (American Society of Mechanical Engineers)*

Founded in 1880, ASME is an organization working to develop codes and standards for the engineering profession, the public, industry and government. Currently, there are more than 600 standards published by ASME on topics such as screw threads, valves, flow measurement and much more.

#### *SAE (Society of Automotive Engineers)*

Since its founding in 1905, SAE has been developing and implementing standards and safety specifically used in designing, building, maintaining and operating self-propelled vehicles.



*ISO (The International Organization for Standardization)*

ISO is a specialized “multinational and multicultural international organization with some 120-member countries governed by consensus and spanning the breadth of global technology.” The object of ISO is to promote the development of standardization and related activities throughout the world. ISO brings together the interests of users (including consumers), producers, governments and the scientific community in the formation of international standards covering everything from screw threads to surgical implants.

ISO publishes standards through members from some 120 countries and more than 800 standards developing committees and subcommittees supported by another 2000 or so working groups. Under the overall coordination of the Technical Management Board, management responsibility for development and maintenance of each ISO standard is first delegated to the main technical committee level and then further to the subcommittees and the working groups.

*DIN (German Engineering Society or Deutsches Institut für Normung)*

DIN is a registered association with its main office in Berlin. It is not a government agency. DIN serves as the round table around which gather representatives for the manufacturing industries, consumer industries, consumer organizations, commerce, service industries, science or anyone with an interest in standardization in order to determine the state of the art and to record it in the form of German standards. DIN standards are technical rules that promote rationalization, quality assurance, safety and environmental protection as well as improving communication between industry, technology, science, government and the public. In DIN, some 40,500 external experts serving as voluntary delegates in some 4400 committees carry out standards work. Published standards are reviewed for continuing relevance at least every five years.

Traditionally, DIN has been the strongest standard for metric products throughout the world. Countries without their own metric standards base have usually referred to DIN in technical documentation and most European countries have also used DIN as the base for their own national standards.

*JIS (Japanese Industrial Institute)*

JIS plays an important role in terms of metric hardware standards. Many JIS standards are based on the DIN standards; however, some of them may be modified to meet the needs they have in Japan. (Typically used for electronic equipment in the US)

**The Metric System**

Throughout history, people have been trying to limit the number of measurement systems. Today, only two systems, inch-pound and metric, are used predominately in most industrial nations. With the exception of the United States and a couple of other nations, all countries in the world are using metric for all their national standards. As with any system, the metric system has also been changing and several modifications have been devised to match the progress of technology.

Today, all nations, including the U.S., have been unifying on one version of metric, known as the International System of Units, or SI. Currently, the U.S. is using both SI and inch-pound standards. Most countries, previously on the inch-pound system, are using SI in new standards and are limiting the use of inch-pound products to maintenance parts for older machinery and equipment. Many U.S. industries, such as the automotive and agricultural industries, have implemented the metric system into their operations.

Another problem has been standardizing within the metric system. Although the intent was to fully convert most metric specifications to an ISO standard, most industries have been slow to convert from the DIN or metric ANSI.

For example, metric hex cap screws are generally manufactured to one of the three standards:

- DIN 931 (DIN 933 fully-threaded)
- ISO 4014 (ISO 4017 fully-threaded)
- ANSI/ASME B18.2.3.1M

Products made to these three standards are interchangeable with each other. Hex cap screws manufactured to the dimensional requirements of any one of the listed standards are usable on nuts manufactured to the tolerances of any of the respective organizations. The main difference between the standards is the width across the flats dimensions for the M10, M12 and M14. For reference, we list the dimensions on page A-20 of the Appendix.

#### *Fastener Property Classes*

The metric system relies on a property class for their strength requirements. The numbering system is very simple; the number prior to the decimal indicates, if multiplied by 100, approximately the minimum tensile strength in Mega Pascals (MPa); the number following the decimal indicates yield as a percentage of the tensile strength.

*Example;* Property Class 10.9

First number 10 indicates a tensile strength of approximately 1000 MPa

The .9 indicates that 90% of tensile strength is approximately the yield strength, or approximately 940 MPa.

Most ASTM specification allows for both metric series and inch series fasteners to be made. For example; ASTM A490 & ASTM A490M. The ASTM A490M is the metric A490 structural bolt (not to be confused with the DIN 6914: 10.9 structural bolt)

#### *Thread*

The metric screw thread is identified by the capital letter M, followed by the nominal diameter. The distance between threads (pitch) in millimeters measures threads on metric threaded fasteners. Threads on a standard (inch based) fastener are measured by counting the number per inch.

#### *Thread Tolerance*

The tolerance system for threads is composed of a number followed by a letter. Numbers indicate the range of tolerance. Capital letters indicate internal (nut) thread tolerance. Small case letters indicate external (bolt) thread tolerance. The 6g-thread tolerance is comparable to a 2A Unified thread tolerance. The 6g tolerance allows room for plating. The 6h tolerance is comparable with the 3A Unified thread tolerance. The 6H tolerance is comparable to a 2B Unified thread tolerance.

Other available thread tolerances:

6e: Used for parts requiring more room for plating.

8g: Used for semi-finished bolts.

5g6g: Used for class 12.9 socket head cap screws (class 8.8 and stainless steel socket head cap screws have 6g tolerance).

4g6g: Used for all socket products regardless of strength class and material. ANSI has specified this tolerance for all socket products.

#### *Example of Metric Description*

Hex Cap Screw Din 931 M16 x 140 Property Class 8.8

- Din 931; indicates partially threaded hex head cap screw
- M16; diameter in mm (16 mm)
- In the metric system, all fasteners are assumed coarse thread unless another thread pitch is stated.
- Length listed in mm (140 mm)
- Property Class must be stated

Charts providing some of the common metric fastener specifications are provided in the appendix.







### Common Specifications for Use with Fasteners

ASTM Specifications			
A36	Specification for Carbon Structural Steel	B695	Specification for Coatings of Zinc Mechanically Deposited on Iron and Steel
A153	Specification for Zinc Coating (Hot-Dip) on Iron and Steel Hardware	F436	Specification for Hardened Steel Washers
A193	Specification for Alloy-Steel and Stainless Steel Bolting Materials for High-Temperature Service	F467	Specification for Nonferrous Nuts for General Use
A194	Specification for Carbon and Alloy Steel Nuts for Bolts for High-Pressure and High-Temperature Service	F468	Specification for Nonferrous Bolts, Hex Cap Screws, and Studs for General Use
A307	Specification for Steel Bolts and Studs, 60,000 PSI Tensile Strength	F593	Specification for Stainless Steel Bolts, Hex Cap Screws, and Studs
A320	Specification for Alloy Steel Bolting Materials for Low-Temperature Service	F594	Specification for Stainless Steel Nuts
A325	Specification for Structural Bolts, Steel, Heat Treated, 120/105 KSI Minimum Tensile Strength	F606	Test Methods for Determining Mechanical Properties of Externally and Internally Threaded Fasteners, Washers, and Rivets
A354	Specification for Quenched and Tempered Alloy Steel Bolts, Studs and Other Externally Threaded Fasteners	F835	Specification for Alloy Steel Socket Button and Flat Countersunk Head Cap Screws
A370	Test Methods and Definitions for Mechanical Testing of Steel Products	F837	Specification for Stainless Steel Socket Head Cap Screws
A394	Specification for Steel Transmission Tower Bolts, Zinc-Coated and Bare	F844	Specification for Washers, Steel, Plain (Flat), Unhardened for General Use
A449	Specification for Quenched and Tempered Steel Bolts and Studs	F879	Specification for Stainless Steel Socket Button and Flat Countersunk Head Cap Screws
A489	Specification for Carbon Steel Lifting Eyes	F880	Specification for Stainless Steel Socket-Set Screws
A490	Specification for Heat-Treated Structural Bolts, 150 KSI Tensile Strength	F912	Specification for Alloy Steel Socket Set Screws
A563	Specification for Carbon and Alloy Steel Nuts	F959	Specification for Compressible-Washer-Type Direct Tension Indicators for Use with Structural Fasteners
A574	Specification for Alloy Steel Socket Head Cap Screw	F1554	Specification for Anchor Bolts, Steel, 36, 55 and 105-ksi Yield Strength
B633	Specification for Electrodeposited Coatings of Zinc on Iron and Steel	F1852	Specification for "Twist Off" Type Tension Control Structural Bolt/Nut/Washer Assemblies, Steel, Heat Treated, 120/105 ksi Minimum Tensile Strength
		F1941	Electrodeposited Coatings on Thread Fasteners [Unified Inch Screw Threads (UN/UNR)]

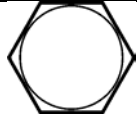
SAE Standards			
J58	Flanged 12 Point Screws	J487	Cotter Pins
J78	Steel Self-Drilling Tapping Screws	J493	Rod Ends and Clevis Pins
J81	Thread Rolling Screws	J933	Mechanical and Quality Requirements for Tapping Screws
J429	Mechanical and Material Requirements for Externally Threaded Fasteners	J995	Mechanical and Material for Steel Nuts

ANSI (and/or) ASME Standards (inch series)			
B1.1	Unified Inch Screw Threads (UN and UNR Thread Form)	B18.6.4	Thread Forming and Thread Cutting Tapping Screws and Metallic Drive Screws
B1.12	Class 5 Interference-Fit Thread	B18.7	General Purpose Semi-Tubular Rivets, Full Tubular Rivets, Split Rivets and Rivet Caps
B1.15	Unified Inch Screw Threads (UNJ Thread Form)	B18.8.1	Clevis Pins and Cotter Pins
B18.1.1	Small Solid Rivets	B18.8.2	Taper Pins, Dowel Pins, Straight Pins, Grooved Pins and Spring Pins
B18.1.2	Large Rivets	B18.9	Plow Bolts
B18.2.1	Square and Hex Bolts and Screws	B18.10	Track Bolts and Nuts
B18.2.2	Square and Hex Nuts	B18.11	Miniature Screws
B18.2.6	Fasteners for Use in Structural Applications	B18.13	Screw and Washer Assemblies (Sems)
B18.3	Socket Cap, Shoulder and Set Screws	B18.15	Forged Eyebolts
B18.5	Round Head Bolts	B18.17	Wing Nuts, Thumb Screws and Wing Screws
B18.6.1	Wood Screws	B18.21.1	Lock Washers
B18.6.2	Slotted Head Cap Screws, Square Head Set Screws, and Slotted Headless Set Screws	B18.22.1	Plain Washers
B18.6.3	Machine Screws and Machine Screw Nuts	B18.23.1	Beveled Washers

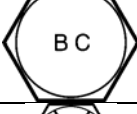
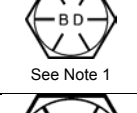
**Mechanical Specifications for Externally Threaded Fasteners with Grade Markings**

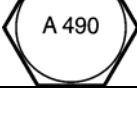

Specification	Material	Size Range (in.)	Min. Proof Strength (psi)	Min. Tensile Strength (psi)	Core Hardness Rockwell		Min. Yield Strength (psi)	Grade Identification Marking
					Min.	Max.		
SAE J429-Grade 1	Low or medium carbon steel	1/4 - 1 1/2	33,000	60,000	B70	B100	36,000	
SAE J429-Grade 2		1/4 - 3/4 7/8 - 1 1/2	55,000 33,000	74,000 60,000	B80 B70	B100 B100	57,000 36,000	
ASTM A307-Grade A	Low or medium carbon steel	1/4 - 4		60,000	B69	B100		
ASTM A307-Grade B	Low or medium carbon steel	1/4 - 4		60,000(min) 100,000(max)	B69	B95		
SAE J429-Grade 5	Medium carbon steel: quenched & tempered	1/4 - 1	85,000	120,000	C25	C34	92,000	
ASTM A449-Type 1		1 1/8 - 1 1/2	74,000	105,000	C19	C30	81,000	
ASTM A449-Type 1		1 3/4 - 3	55,000	90,000			58,000	
ASTM A325-Type 1	Medium carbon steel: quenched & tempered	1/2 - 1 1 1/8 - 1 1/2	85,000 74,000	120,000 105,000	C25 C19	C34 C30	92,000 81,000	
ASTM A354 Grade BC	Medium carbon alloy steel: quenched & tempered	1/4 - 2 1/2 Over 2 1/2 - 4	105,000 95,000	125,000 115,000	C26 C22	C36 C33	109,000 99,000	
ASTM A354 Grade BD	Medium carbon alloy steel: quenched & tempered	1/4 - 2 1/2 Over 2 1/2 - 4	120,000 105,000	150,000 140,000	C33 C31	C39 C39	130,000 115,000	 See Note 1
SAE J429-Grade 8	Medium carbon alloy steel: quenched & tempered	1/4 - 1 1/2	120,000	150,000	C33	C39	130,000	
SAE J429-Grade 8.2	Low carbon boron steel: quenched & tempered	1/4 - 1	120,000	150,000	C33	C39	130,000	
ASTM A490-Type 1	Medium carbon alloy steel: quenched & tempered	1/2 - 1 1/2	120,000	150,000(min) 173,000(max)	C33	C39	130,000	
ASTM A574 Alloy Steel Socket Head Cap Screw	Medium carbon alloy steel: quenched & tempered	#0 - 1/2 over 1/2 - 2	140,000 135,000	180,000 170,000	C39 C37	C45 C45	153,000	
ASTM F835 Alloy Steel Socket Button & Flat Countersunk Head Cap Screw	Medium carbon alloy steel: quenched & tempered	#0 - 1/2 Over 1/2		145,000 135,000	C39 C37	C44 C44		

Note 1: ASTM A354-Grade BD shall be marked "BD", and in addition to "BD", the product may be marked six radial lines 60° apart.

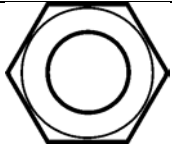

**Material Specification**

Specification	Material	Tensile Strength (psi)	Min. Yield Strength (psi)
ASTM A36	Carbon Structural Steel	58,000 (min.) - 80,000 (max.)	36,000

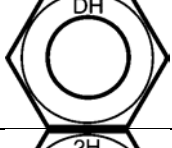
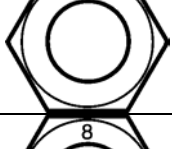
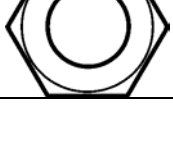
### Grade Identification Markings for Nuts

Specification	Material	Nominal Size(in.)	Proof Load Stress (psi)		Hardness Rockwell		Grade Identification Marking
			Plain	Zinc Coated (1)	Min.	Max.	
ASTM A563-Grade 0	Carbon Steel	1/4 - 1 1/2	69,000*	52,000*	B55	C32	
ASTM A563-Grade A	Carbon Steel	1/4 - 1 1/2	90,000*	68,000*	B68	C32	
ASTM A563-Grade A Heavy Hex	Carbon Steel	1/4 - 4	100,000* 90,000**	75,000* 68,000**	B68	C32	
ASTM A563-Grade C Heavy Hex	Carbon Steel, may be quenched and tempered	1/4 - 4	144,000		B78	C38	
ASTM A563-Grade DH Heavy Hex	Carbon Steel, quenched and tempered	1/4 - 4	175,000	150,000	C24	C38	
ASTM A194-Grade 2H Heavy Hex	Medium Carbon Steel	1/4 - 1 1/2	175,000	150,000** *	C24	C35	
		Over 1 1/2				C35	
ASTM A194-Grade 8 Heavy Hex	AISI 304	1/4 - 1 1/2	80,000		B60	B105	

### SAE J995 Grade Identification for Nuts

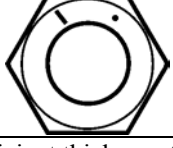
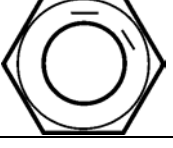
Grade	Material	Nominal Size(in.)	Proof Load Stress (psi)	Rockwell Hardness		Grade Identification Markings	
				Min.	Max.	Previous ****	Revised****
5	Carbon steel	1/4 - 1	120,000*		C32		
			109,000**				
		Over 1 - 1 1/2	105,000*		C32		
			94,000**				
8	Medium carbon or alloy steel, quenched & tempered	1/4 - 5/8	150,000	C24	C32		
		Over 5/8 - 1		C26	C34		
		Over 1 - 1 1/2		C26	C36		

(1): Zinc coating refers to nuts that have been plated with a plating or coating of sufficient thickness to require overtapping of the nut to provide assembly: for example hot-dip or mechanical galvanizing.

\* UNC and 8 UN

\*\* UNF, 12 UN & finer

\*\*\*When a zinc coated A194 2H nut is supplied, the zinc coating, overtapping, lubrication and rotational capacity testing shall be in accordance with ASTM A563 and the proof stress reduced accordingly. Nuts coated with zinc shall have an asterisk "\*" marked after the grade symbol. Nuts coated with cadmium shall have a plus sign "+" marked after the grade symbol.

\*\*\*\*These graded identification markings show the latest revision. Both markings will be acceptable for a transition period.

Typically, the bolt specification dictates which nuts are compatible for use. However, when in doubt, the #1 Rule for Nut Selection: Always select a nut whose minimum proof strength is greater than or equal to the bolts minimum ultimate tensile capacity. The following charts are some examples of compatible nut and bolt combinations.

**SAE J429 Bolt and Nut Compatibility**

Bolt Grade	Recommended Nut Grade (1)	Suitable Substitution (2)
SAE J-429 Grade 2	Low Carbon Regular or Heavy Hex Nut	SAE J995 Grade 5 or Grade 8 Hex Nut
SAE J-429 Grade 5	SAE J995 Grade 5 Hex Nut	SAE J995 Grade 8 Hex Nut
SAE J-429 Grade 8	SAE J995 Grade 8 Hex Nut	

- (1) "Recommended" denotes a commercially available nut having the most suitable mechanical properties that will make it possible to obtain the desired bolt load.  
 (2) "Suitable" denotes SAE J995 nuts having mechanical properties that will also make it possible to obtain the desired bolt load.





**ASTM Bolt and ASTM A563 Nut Compatibility  
 (ASTM A194 Compatibility shown for A325, A490 & A193 Bolts)**

Grade of Bolt (A)	Surface Finish (B)	Nominal Size (in.)	ASTM A563 Grade and ANSI Style Nut (C)	
			Recommended (D)	Suitable Substitution (E) Heavy Hex
ASTM A307 Grade A	Plain & Zinc Coated	1/4 to 1-1/2	Grade A Hex Nut	A,C,DH
		over 1-1/2 to 2	Grade A Heavy Hex Nut	C,DH
		Over 2 to 4	Grade A Heavy Hex Nut	C,DH
ASTM A307 Grade B	Plain & Zinc Coated	1/4 to 1-1/2	Grade A Heavy Hex Nut	C,DH
		over 1-1/2 to 2	Grade A Heavy Hex Nut	C,DH
		Over 2 to 4	Grade A Heavy Hex Nut	C,DH
ASTM A449 Types 1 & 2	Plain	1/4 to 1-1/2	Grade B Hex Nut	C,DH
		Over 1-1/2 to 3	Grade A Heavy Hex Nut	C,DH
	Zinc Coated	1/4 to 1-1/2	Grade DH Heavy Hex Nut	
		Over 1-1/2 to 3	Grade DH Heavy Hex Nut	
ASTM A325	Plain	1/2 to 1-1/2	Grade C Heavy Hex Nut	DH, ASTM A194 2H
	Zinc Coated	1/2 to 1-1/2	Grade DH Heavy Hex Nut	ASTM A194 2H
ASTM A354 Grade BC	Plain	1/4 to 1-1/2	Grade C Heavy Hex Nut	DH
		Over 1-1/2 to 4	Grade C Heavy Hex Nut	DH
	Zinc Coated	1/4 to 1-1/2	Grade DH Heavy Hex Nut	
		Over 1-1/2 to 4	Grade DH Heavy Hex Nut	
ASTM A354 Grade BD	Plain	1/4 to 1-1/2	Grade DH Heavy Hex Nut	DH
		Over 1-1/2 to 3	Grade DH Heavy Hex Nut	
ASTM A490	Plain	1/2 to 1-1/2	Grade DH Heavy Hex Nut	ASTM A194 2H
ASTM A193 Grade B7			ASTM A194 2H Heavy Hex Nut	ASTM A194 7
ASTM A193 Grade B8			ASTM A194 Grade 8	
ASTM A193 Grade B8M			ASTM A194 Grade 8M	

Note: the above chart should not be considered all inclusive for all fasteners listed. The nuts listed are those that may be readily available.

- (A) "Bolt" includes all externally threaded types of fasteners.  
 (B) Zinc coated nuts are nuts intended for use with externally threaded fasteners which are hot-dip zinc-coated, mechanically zinc-coated or have a plating or coating of sufficient thickness to require overtapping the nut to provide assembly. Non-zinc plated nuts are nuts intended for use with externally threaded fasteners which have a plain finish or have a plating or coating of insufficient thickness to require overtapping the nut thread to provide assembly.  
 (C) The availability of DH nuts in nominal sizes 3/4" and larger is limited. In most instances ASTM A194 Grade 2H nuts may be considered.  
 (D) "Recommended" denotes a commercially available nut having the most suitable mechanical properties and dimensional configuration, or style, which will make it possible to obtain the desired bolt load.  
 (E) "Suitable" denotes nuts having mechanical properties that will make it possible to obtain the desired bolt load, but require consideration of dimensional configuration, or style, suitability and availability.

**Mechanical Properties of Common Stainless Steel Fasteners in Accordance with ASTM F593**

Stainless Alloy Group	Condition	Nominal Dia. (in.)	Tensile Strength (psi)	Core Hardness Rockwell		Min. Yield Strength (psi)	Grade Identification Marking
				Min.	Max.		
1 (303, 304, 304L, 305, 384, XM1, 18-9LW, 302HQ, 303Se)	CW	1/4 - 5/8	100,000 - 150,000	B95	C32	65,000	
	CW	3/4 - 1 1/2	85,000 - 140,000	B80	C32	45,000	
2 (316, 316L)	CW	1/4 - 5/8	100,000 - 150,000	B95	C32	65,000	
	CW	3/4 - 1 1/2	85,000 - 140,000	B80	C32	45,000	

CW: headed and rolled from annealed or solution-annealed stock

**ASTM A193: Alloy Steel and Stainless Steel Bolting Material For High-Temperature Service**

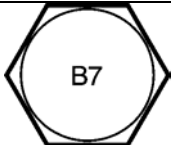
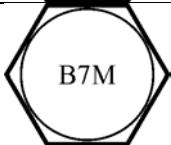
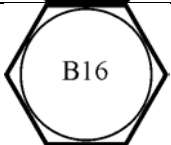
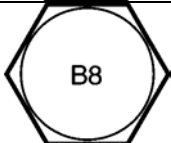
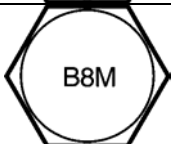
Specification & Grade	Size Range (in.)	Min. Tensile Strength (psi)	Min. Yield Strength (psi)	Core Hardness Rockwell (max)	Description	Grade Identification Marking
ASTM A193 B7	2 1/2 & under	125,000	105,000	C35	Chromium-Molybdenum alloy (4140, 4142, 4145, 4140H, 4142H, 4145H) used for high-pressure, high-temperature applications.	
	Over 2 1/2 - 4	115,000	95,000	C35		
	Over 4 - 7	100,000	75,000	C35		
ASTM A193 B7M	4 & under	100,000	80,000	B99	Similar to B7 except heat-treated to limit the maximum hardness. Considered in areas where stress embrittlement may be a factor.	
	Over 4 - 7	100,000	75,000	B99		
ASTM A193 B16	2 1/2 & under	125,000	105,000	C35	A chromium-Molybdenum-Vanadium alloy used for high-pressure, high-temperature service applications. Offers slightly higher temperature resistance than B7.	
	Over 2 1/2 - 4	110,000	95,000	C35		
	Over 4 - 8	100,000	85,000	C35		
ASTM A193 B8 Class 1	1/4 & larger	75,000	30,000	B96	A 304 Stainless Steel used for high temperature applications. This material has been carbide solution treated.	
ASTM A193 B8M Class 1	1/4 & larger	75,000	30,000	B96	A 316 Stainless Steel used for high temperature applications. This material has been carbide solution treated.	

**Caution:** All material included in this chart is advisory only, and its use by anyone is voluntary. In developing this information, Fastenal has made a determined effort to present its contents accurately. Extreme caution should be used when using a formula for torque/tension relationships. Torque is only an indirect indication of tension. For assemblies where loosening or bolt failures can result in personal injury or costly equipment failure, the torque-tension relationship should be determined experimentally on the actual parts involved.

**Torque-Tension Relationships for SAE J429 Grade Bolts**

Nominal Dia. (in.)	threads per inch	SAE J429 Grade 2			SAE J429 Grade 5			SAE J429 Grade 8					
		Clamp Load (Lbs.)	Tightening Torque			Clamp Load (Lbs.)	Tightening Torque			Clamp Load (Lbs.)	Tightening Torque		
			K = 0.15	K = 0.18	K = 0.20		K = 0.15	K = 0.18	K = 0.20		K = 0.15	K = 0.18	K = 0.20
Unified Coarse Thread Series													
1/4	20	1313	49 in-lbs	59 in-lbs	66 in-lbs	2029	76 in-lbs	91 in-lbs	101 in-lbs	2864	107 in-lbs	129 in-lbs	143 in-lbs
5/16	18	2163	101	122	135	3342	157	188	209	4719	221	265	295
3/8	16	3196	15 ft-lbs	18 ft-lbs	20 ft-lbs	4940	23 ft-lbs	28 ft-lbs	31 ft-lbs	6974	33 ft-lbs	39 ft-lbs	44 ft-lbs
7/16	14	4385	24	29	32	6777	37	44	49	9568	52	63	70
1/2	13	5853	37	44	49	9046	57	68	75	12771	80	96	106
5/8	11	9323	73	87	97	14408	113	135	150	20340	159	191	212
3/4	10	13797	129	155	172	21322	200	240	267	30101	282	339	376
7/8	9	11428	125	150	167	29436	322	386	429	41556	455	545	606
1	8	14992	187	225	250	38616	483	579	644	54517	681	818	909
Fine Thread Series													
1/4	28	1500	56 in-lbs	68 in-lbs	75 in-lbs	2319	87 in-lbs	104 in-lbs	116 in-lbs	3274	123 in-lbs	147 in-lbs	164 in-lbs
5/16	24	2395	112	135	150	3702	174	208	231	5226	245	294	327
3/8	24	3623	17 ft-lbs	20 ft-lbs	23 ft-lbs	5599	26 ft-lbs	31 ft-lbs	35 ft-lbs	7905	37 ft-lbs	44 ft-lbs	49 ft-lbs
7/16	20	4897	27	32	36	7568	41	50	55	10684	58	70	78
1/2	20	6598	41	49	55	10197	64	76	85	14396	90	108	120
5/8	18	10558	82	99	110	16317	127	153	170	23036	180	216	240
3/4	16	15385	144	173	192	23776	223	267	297	33566	315	378	420
7/8	14	12609	138	165	184	32479	355	426	474	45853	502	602	669
1	14 (UNS)	16827	210	252	280	43343	542	650	722	61190	765	918	1020

Clamp load estimated as 75% of proof load for specified bolts.

Torque values for 1/4 and 5/16-inch series are in inch-pounds. All other torque values are in foot-pounds.

Torque values calculated from formula  $T = KDF$

where: D is the nominal diameter, F is the clamp load and

K=0.15 for "lubricated" conditions

K=0.18 for zinc plated and dry conditions

K=0.20 for plain and dry conditions

The nut or tapped hole is as critical to torque as the bolt. WHEN USING GRADE C TOPLOCK NUTS OR FLANGE LOCKNUTS, PLEASE REFER TO THE FOLLOWING INFORMATION.

**Torque-Tension Relationships for Electrodeposited Zinc Clear Chromate, and Lubricated Prevailing Torque Lock Nuts**

Locknut Size	Steel Hex Locknut			Steel Hex Flange Locknut					
	Grade C Locknut			Grade F Locknut			Grade G Locknut		
	Clamp Load (lbs)	Tightening Torque (ft-lbs.)		Clamp Load (lbs)	Tightening Torque (ft-lbs.)		Clamp Load (lbs)	Tightening Torque (ft-lbs.)	
		Max.	Min.		Max.	Min.		Max.	Min.
Unified Coarse Thread Series									
1/4 - 20	2850	14.7	10.0	2000	11.1	7.6	2850	17.6	11.7
5/16 - 18	4700	22.3	15.2	3350	21.1	14.1	4700	28.1	18.2
3/8 - 16	6950	39	28	4950	37	23	6950	45	30
7/16 - 14	9600	60	44	6800	59	39	9600	72	48
1/2 - 13	12,800	88	63	9050	80	53	12,800	120	77
9/16 - 12	16,400	134	98	11,600	120	77	16,400	169	113
5/8 - 11	20,300	172	127	14,500	158	106	20,300	201	134
3/4 - 10	30,100	295	218	21,300	274	190	30,100	338	225
7/8 - 9	41,600	440	317						
1 - 8	54,600	651	506						

Clamp loads for Grades C and G nuts equal 75% of the proof loads specified for SAE J429 Grade 8.

Clamp loads for Grade F nuts equal 75% of the proof load specified for SAE J429 Grade 5.

All torque values are in foot-pounds.



**Caution:** All material included in this chart is advisory only, and its use by anyone is voluntary. In developing this information, Fastenal has made a determined effort to present its contents accurately. Extreme caution should be used when using a formula for torque/tension relationships. Torque is only an indirect indication of tension. For assemblies where loosening or bolt failures can result in personal injury or costly equipment failure, the torque-tension relationship should be determined experimentally on the actual parts involved.

**Torque-Tension Relationships for ASTM A574 Socket Head Cap Screws**

Nominal Dia. (in.)	Unified Coarse Thread Series					Fine Thread Series				
	threads per inch	Tensile Stress Area (sq. in.)	Clamp Load (lbs)	Tightening Torque		threads per inch	Tensile Stress Area (sq. in.)	Clamp Load (lbs)	Tightening Torque	
				K = 0.15 (ft-lbs)	K = 0.20 (ft-lbs)				K = 0.15 (ft-lbs)	K = 0.20 (ft-lbs)
1/4	20	0.0318	3341	10	14	28	0.0364	3819	12	16
5/16	18	0.0524	5505	22	29	24	0.0581	6097	24	32
3/8	16	0.0775	8136	38	51	24	0.0878	9222	43	58
7/16	14	0.1063	11162	61	81	20	0.1187	12465	68	91
1/2	13	0.1419	14899	93	124	20	0.1600	16795	105	140
5/8	11	0.2260	22883	179	238	18	0.2560	25916	202	270
3/4	10	0.3345	33864	317	423	16	0.3730	37762	354	472
7/8	9	0.4617	46751	511	682	14	0.5095	51584	564	752
1	8	0.6057	61332	767	1022	14	0.6799	68839	860	1147

Clamp load estimated as 75% of proof load for socket head cap screws as specified in ASTM A574.

All torque values are in foot-pounds.

Torque values calculated from formula  $T = KDF$

where: K=0.15 for "lubricated" conditions

K=0.20 for "dry" conditions

**Torque Values for Stainless Steel and Nonferrous Fasteners (inch series)**

The following torque values are suggested maximums based upon actual lab testing on clean and dry or near dry fasteners. For other friction conditions, significant modifications may be required.

Values though 7/16-inch diameter are stated in inch-pounds: 1/2-inch and over are stated in foot-pounds.

Bolt Size	18-8 Stainless Steel Torque	316 Stainless Steel Torque	Silicon Bronze	Monel	Brass	2024-T4 Aluminum
4-40	5.2 in-lbs	5.5 in-lbs	4.8 in-lbs	5.3 in-lbs	4.3 in-lbs	2.9 in-lbs
4-48	6.6	6.9	6.1	6.7	5.4	3.6
5-40	7.7	8.1	7.1	7.8	6.3	4.2
5-44	9.4	9.8	8.7	9.6	7.7	5.1
6-32	9.6	10.1	8.9	9.8	7.9	5.3
6-40	12.1	12.7	11.2	12.3	9.9	6.6
8-32	19.8	20.7	18.4	20.2	16.2	10.8
8-36	22	23	20.4	22.4	18.0	12.0
10-24	22.8	23.8	21.2	25.9	18.6	13.8
10-32	31.7	33.1	29.3	34.9	25.9	19.2
1/4-20	75.2	78.8	68.8	85.3	61.5	45.6
1/4-28	94	99	87	106	77	57
5/16-18	132	138	123	149	107	80
5/16-24	142	147	131	160	116	86
3/8-16	236	247	219	266	192	143
3/8-24	259	271	240	294	212	157
7/16-14	376	393	349	427	317	228
7/16-20	400	418	371	451	327	242
1/2-13	43 ft-lbs	45 ft-lbs	40 ft-lbs	48.7 ft-lbs	35.2 ft-lbs	26 ft-lbs
1/2-20	45	47	42	51	37	27
9/16-12	56	59	53	65	47	34
9/16-18	62	65	58	71	51	38
5/8-11	92	96	86	111	76	60
5/8-18	103	108	96	123	85	67
3/4-10	127	131	118	153	104	82
3/4-16	124	129	115	149	102	80
7/8-9	194	202	178	231	159	124
7/8-14	193	201	177	230	158	124
1 - 8	286	299	265	344	235	184
1 - 14	259	270	240	311	212	166

### Unified National Thread Tensile Stress Area (As)

Nominal Size	Coarse Thread		8 Thread Series		Fine Thread	
	Thread Pitch (tpi)	Tensile Stress Area (sq in.)	Thread Pitch (tpi)	Tensile Stress Area (sq in.)	Thread Pitch (tpi)	Tensile Stress Area (sq in.)
0	0.060				80	0.00180
1	0.073	64			72	0.00278
2	0.086	56			64	0.00394
3	0.099	48			56	0.00523
4	0.112	40			48	0.00661
5	0.125	40			44	0.00831
6	0.138	32			40	0.01015
8	0.164	32			36	0.0147
10	0.190	24			32	0.0200
12	0.216	24			28	0.0258
1/4	0.250	20			28	0.0364
5/16	0.313	18			24	0.0581
3/8	0.375	16			24	0.0878
7/16	0.438	14			20	0.119
1/2	0.500	13			20	0.160
9/16	0.563	12			18	0.203
5/8	0.625	11			18	0.256
3/4	0.750	10			16	0.373
7/8	0.875	9			14	0.510
1	1.000	8	8	0.606	12 UNF	0.663
1	1.000				14 UNS	0.680
1 1/8	1.125	7	8	0.791	12	0.856
1 1/4	1.250	7	8	1.000	12	1.073
1 3/8	1.375	6	8	1.234	12	1.315
1 1/2	1.500	6	8	1.492	12	1.581

The tensile stress area is calculated as follows:

$$A_s = 0.7854 [D - (0.9743/n)]^2$$

where

$A_s$  = stress area (in sq.)

$D$  = nominal bolt size (in.)

$n$  = threads per inch

### Metric (SI) System Thread Tensile Stress Area (As)

Nom Dia. (mm)	Coarse Thread		Fine Thread	
	Thread Pitch (mm)	Tensile Stress Area (mm sq.)	Thread Pitch (mm)	Tensile Stress Area (mm sq.)
3	0.5	5.03		
3.5	0.6	6.78		
4	0.7	8.78		
5	0.8	14.2		
6	1	20.1		
7	1	28.9		
8	1.25	36.6	1	39.2
10	1.5	58.0	1.25	61.2
12	1.75	84.3	1.25	92.1
14	2	115	1.5	125
16	2	157	1.5	167
18	2.5	192	1.5	216
20	2.5	245	1.5	272
22	2.5	303	1.5	333
24	3	353	2	384
27	3	459	2	496
30	3.5	561	2	621
33	3.5	694	2	761
36	4	817	3	865
39	4	976	3	1030

The tensile stress area is calculated as follows:

$$A_s = 0.7854 [D - (0.9743P)]^2$$

where

$A_s$  = stress area (mm sq.)

$D$  = nominal bolt size (mm)

$P$  = thread pitch (mm)

### U.S./Metric Conversion Equivalents





Quantity	To Convert	Into	Multiply By	To Convert	Into	Multiply By
Length	inch (in.)	millimeter(mm)	25.4	mm	inch	0.03937
	feet (ft)	millimeter(mm)	304.8	mm	feet	0.00328
Area	square inch (sq.in)	square millimeter (sq. mm)	645.16	sq. mm	sq. in.	0.00155
Volume	gallon	liter	3.785	liter	gal	0.2642
	cubic inch	cubic centimeter	16.3871			
	cubic foot	cubic meter	0.0283			
Force	pound (lb.)	Newton(N)	4.448	N	lb.	0.2248
Pressure	pound/sq.in(psi)	Pascal(Pa)	6895	MPa	psi	145.1
		Mega Pascal(MPa)	0.006895			
Torque	inch pound(in-lb)	Newton meter(N m)	0.113	N m	in-lb	8.851
	foot pound(ft-lb)	Newton meter(N m)	1.356	N m	ft-lb	0.738

Other common conversions: 1N = 1 kg m/s<sup>2</sup> ; 1Pa = 1N/m<sup>2</sup> ; 1MPa = 1N/mm<sup>2</sup>

Example: to convert length to mm, multiply inches by 25.4

**Caution:** All material included in this chart is advisory only, and its use by anyone is voluntary. In developing this information, Fastenal has made a determined effort to present its contents accurately. Extreme caution should be used when using a formula for torque/tension relationships. Torque is only an indirect indication of tension. For assemblies where loosening or bolt failures can result in personal injury or costly equipment failure, the torque-tension relationship should be determined experimentally on the actual parts involved.

**Torque-Tension Relationships For Metric Fasteners**

Nom. Dia. (mm)	Pitch	 Class 4.6			 Class 8.8			 Class 10.9			 Class 12.9					
		Clamp Load (lbs)	Tightening Torque			Clamp Load (lbs)	Tightening Torque			Clamp Load (lbs)	Tightening Torque			Clamp Load (lbs)	Tightening Torque	
			K = 0.15 (ft-lbs)	K = 0.18 (ft-lbs)	K = 0.20 (ft-lbs)		K = 0.15 (ft-lbs)	K = 0.18 (ft-lbs)	K = 0.20 (ft-lbs)		K = 0.15 (ft-lbs)	K = 0.20 (ft-lbs)				
3	0.5												823	1.2	1.6	
3.5	0.6												1108	1.9	2.5	
4	0.7												1436	2.8	3.8	
5	0.8	538	1.3	1.6	1.8	1387	3.4	4.1	4.5	1985	4.9	5.9	6.5	2319	5.7	7.6
6	1	763	2.3	2.7	3.0	1968	5.8	7.0	7.7	2816	8.3	10.0	11.1	3291	9.7	13.0
7	1	1095	3.8	4.5	5.0	2822	9.7	11.7	13.0	4039	13.9	16.7	18.5	4720	16.3	21.7
8	1.25	1389	5.5	6.6	7.3	3580	14.1	16.9	18.8	5123	20.2	24.2	26.9	5987	23.6	31.4
10	1.5	2200	10.8	13.0	14.4	5671	27.9	33.5	37.2	8115	39.9	47.9	53.2	9484	46.7	62.2
12	1.75	3197	18.9	22.7	25.2	8240	48.7	58.4	64.9	11792	69.6	83.5	92.8	13781	81.4	108.5
14	2	4379	30.2	36.2	40.2	11289	77.8	93.3	103.7	16154	111.3	133.5	148.4	18879	130.0	173.4
16	2	5943	46.8	56.2	62.4	15320	120.6	144.7	160.8	21924	172.6	207.1	230.1	25622	201.7	268.9
18	2.5	7301	64.7	77.6	86.2	18822	166.7	200.0	222.2	26934	238.5	286.2	318.0	31477	278.8	371.7
20	2.5	9286	91.4	109.7	121.9	23938	235.5	282.7	314.1	34256	337.1	404.5	449.4	40034	393.9	525.2
22	2.5	11509	124.6	149.5	166.1	29669	321.1	385.4	428.2	42457	459.6	551.5	612.7	49619	537.1	716.1
24	3	13372	157.9	189.5	210.6	34471	407.0	488.4	542.7	49329	582.5	699.0	776.6	57649	680.7	907.6
27	3	17428	231.6	277.9	308.8	44924	596.8	716.1	795.7	64288	854.0	1024.8	1138.7	75132	998.1	1330.7
30	3.5	21266	314.0	376.8	418.6	54819	809.1	970.9	1078.8	78448	1157.9	1389.5	1543.8	91680	1353.2	1804.3
33	3.5	26310	427.3	512.7	569.7	67821	1101.1	1321.4	1468.2	97055	1575.8	1890.9	2101.0	113425	1841.6	2455.4
36	4	30982	548.9	658.7	731.9	79866	1414.6	1697.5	1886.1	114291	2024.3	2429.2	2699.1	133569	2365.8	3154.4



Clamp load estimated as 75% of proof load for specified bolts.

Torque values are listed in foot-pounds.

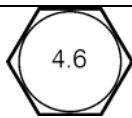
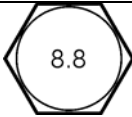
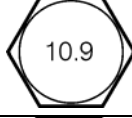

Torque values calculated from formula  $T = KDF$

- where: D is the nominal diameter, F is the clamp load and
- K=0.15 for "lubricated" conditions
- K=0.18 for zinc plated and dry conditions
- K=0.20 for plain and dry conditions

**Metric Mechanical Specifications with Grade Markings per ISO 898-1**

Metric Property Class	Material	Size Range	Min. Proof Strength MPa	Min. Tensile Strength MPa	Core Hardness Rockwell		Min. Yield Strength MPa	Grade Identification Marking
					Min.	Max.		
4.6	Low or medium carbon steel	M5 - M39	225	400	B67	B99.5	240	
8.8	Medium carbon steel: quenched & tempered	M5 - M16 M18 - M39	580 600	800 830	C22 C23	C32 C34	640 660	
10.9	Alloy steel: quenched & tempered	M5 - M39	830	1040	C32	C39	940	
12.9	Alloy steel: quenched & tempered	M1.6 - M39	970	1220	C39	C44	1100	

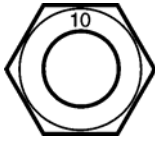
**Mechanical Properties of Metric Nuts per ISO 898-2**

Standard & Class	Material	Nominal Size (mm)	Proof Stress N/mm	Grade Identification Marking
ISO 898/2 - Class 8	Medium carbon steel, quenched & tempered	up to 4	800	
		over 4 to 7	855	
		over 7 to 10	870	
		over 10 to 16	880	
		over 16 to 39	920	
ISO 898/2 - Class 10	Low carbon alloy steel, quenched & tempered	up to 10	1040	
		over 10 to 16	1050	
		over 16 to 39	1060	
ISO 898/2 - Class 12	Alloy steel, quenched & tempered	up to 10	1140	
		over 7 to 10	1160	
		over 10 to 16	1170	
		over 16 to 39	1200	

**ISO 3506 Corrosion-Resistant Stainless Steel Fasteners**

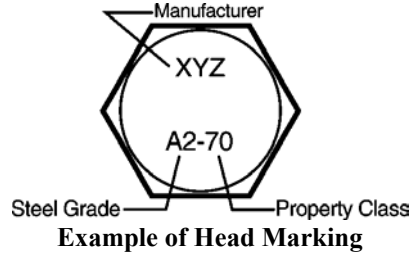

**Mechanical Properties of Metric Stainless Steel Fasteners**

Group	Grade	Property Class	Diameter Range	Bolts, Screws & Studs		Nuts Proof Load Stress N/mm <sup>2</sup>
				Tensile Strength N/mm <sup>2</sup>	Stress at 0.2% Permanent Strain N/mm <sup>2</sup>	
Austenitic	A1, A2 & A4	50 (soft)	≤M39	500	210	500
		70 (cold-worked)	≤M20	700	450	700
		80 (high strength)	≤M20	800	600	800
Martensitic	C1	50 (soft)		500	250	500
		70 (hardened & tempered)		700	410	700
	C3	80 (hardened & tempered)		800	640	800
C4	50 (soft)		500	250	500	
	70 (hardened & tempered)		700	410	700	
Ferritic	F1	45 (soft)	≤M24	450	250	450
		60 (cold-worked)	≤M24	600	410	600

The following chart is designed to aid with the selection of fasteners based on galvanic action. For a detailed explanation see the corrosion section.

**Fastener material selection based on the Galvanic Series of Metals**

Fastener Metal ↓ Base Metal	Zinc & Galvanized Steel	Aluminum & Aluminum Alloys	Steel & Cast Iron	Brasses, Copper, Bronzes & Monel	Martensitic Stainless Type 410	Austenitic Stainless Type 302/304, 303, 305
Zinc & Galvanized Steel	1	2	2	3	3	3
Aluminum & Aluminum Alloys	1	1	2	3	Never Recommended	2
Steel & Cast Iron	1,4	1	1	3	3	2
Terne (lead-tin) Plated Steel Sheets	1,4,5	1,5	1,5	3	3	2
Brasses, Copper, Bronzes & Monel	1,4,5	1,5	1,5	1	1	2
Ferritic Stainless Steel (type 430)	1,4,5	1,5	1,5	1	1	1
austenitic Stainless Steel (type 302/304)	1,4,5	1,5	1,5	1,5	1	1

Key:

1. The corrosion of the base metal is not increased by the fastener.
2. The corrosion of the base metal is marginally increased by the fastener.
3. The corrosion of the base metal may be considerably increased by the fastener material.
4. The plating on the fastener is rapidly consumed, leaving the bare fastener metal.
5. The corrosion of the fastener is increased by the base metal.

NOTE: Surface treatment and environment can significantly alter activity.

## Forged Eyebolts

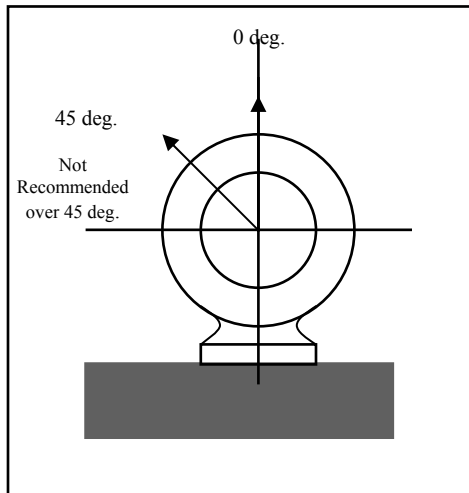

Nominal Size (in.)	Lifting Eye Capacities	
	Working Load Limit (lbs)	
	0 degrees	45 degrees (shoulder pattern)
1/4	500	125
5/16	900	225
3/8	1300	325
7/16	1800	450
1/2	2400	600
9/16	3200	800
5/8	4000	1000
3/4	5000	1250
7/8	7000	1750
1	9000	2250
1-1/8	12,000	3000
1-1/4	15,000	3750
1-1/2	21,000	5250
2	38,000	9500

- Capacities shown are for carbon steel ASTM A489 eyebolts, at temperatures between 30°F and 275°F. Carbon steel is subject to shock loading at temperatures below 30° F and loses strength at temperatures above 275°F.
- Shoulder lifting eyes must be properly seated against mating surface for full working capacity. A steel washer or spacer may be required for proper seating.
- The minimum thread engagement should be 1-1/2 times the thread diameter in steel.
- Loads must always be applied in the plane of the eye, not at an angle to this plane (see diagram below).

## Load Application

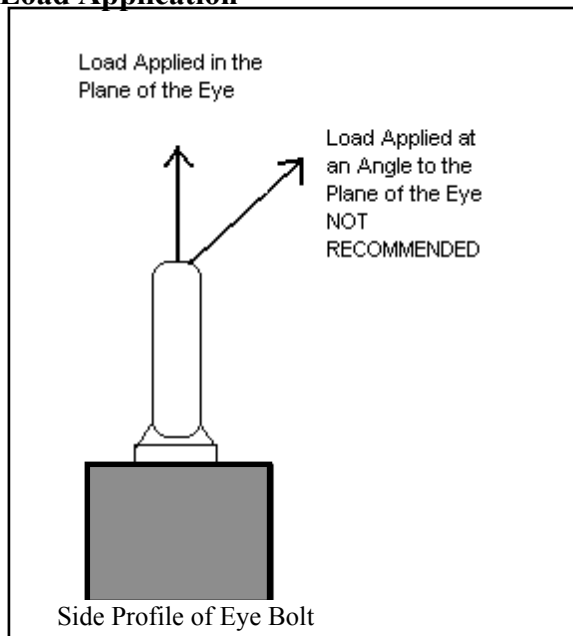

- For vertical lifts, plain pattern and shoulder pattern eyebolts are theoretically equal. However, a plain pattern eye bolt should never be used for angular lifting.
- Lifting eyes should never be used if there are any visible signs of wear or damage.

# Specifications

## Hex Bolts

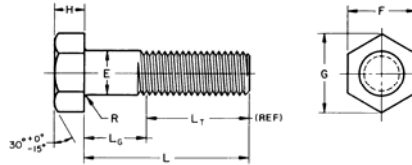

Nominal Size (inch)	E		F			G		H			Thread Length For Bolt Lengths	
	Full Size Body Dia.		Width Across Flats			Width Across Corners		Head Height			6 in & Shorter	Over 6 in
	Max.	Min.	Basic	Max.	Min.	Max.	Min.	Basic	Max.	Min.	Nom.	Nom.
1/4	0.260	0.237	7/16	0.438	0.425	0.505	0.484	11/64	0.188	0.150	0.750	1.000
5/16	0.324	0.298	1/2	0.500	0.484	0.577	0.552	7/32	0.235	0.195	0.875	1.125
3/8	0.388	0.360	9/16	0.563	0.544	0.650	0.620	1/4	0.268	0.226	1.000	1.250
7/16	0.452	0.421	5/8	0.625	0.603	0.722	0.687	19/64	0.316	0.272	1.125	1.375
1/2	0.515	0.482	3/4	0.750	0.725	0.866	0.826	11/32	0.364	0.302	1.250	1.500
5/8	0.642	0.605	15/16	0.938	0.906	1.083	1.033	27/64	0.444	0.378	1.500	1.750
3/4	0.768	0.729	1 1/8	1.125	1.088	1.299	1.240	1/2	0.524	0.455	1.750	2.000
7/8	0.895	0.852	1 5/16	1.313	1.269	1.516	1.447	37/64	0.604	0.531	2.000	2.250
1	1.022	0.976	1 1/2	1.500	1.450	1.732	1.653	43/64	0.700	0.591	2.250	2.500
1 1/8	1.149	1.098	1 11/16	1.688	1.631	1.949	1.859	3/4	0.780	0.658	2.500	2.750
1 1/4	1.277	1.223	1 7/8	1.875	1.812	2.165	2.066	27/32	0.876	0.749	2.750	3.000
1 3/8	1.404	1.345	2 1/16	2.063	1.994	2.382	2.273	29/32	0.940	0.810	3.000	3.250
1 1/2	1.531	1.470	2 1/4	2.250	2.175	2.598	2.480	1	1.036	0.902	3.250	3.500
1 3/4	1.785	1.716	2 5/8	2.625	2.538	3.031	2.893	1 5/32	1.196	1.054	3.750	4.000
2	2.039	1.964	3	3.000	2.900	3.464	3.306	1 11/32	1.388	1.175	4.250	4.500
2 1/4	2.305	2.214	3 3/8	3.375	3.262	3.897	3.719	1 1/2	1.548	1.327	4.750	5.000
2 1/2	2.559	2.461	3 3/4	3.750	3.625	4.330	4.133	1 21/32	1.708	1.479	5.250	5.500
2 3/4	2.827	2.711	4 1/8	4.125	3.988	4.763	4.546	1 13/16	1.869	1.632	5.750	6.000
3	3.081	2.961	4 1/2	4.500	4.350	5.196	4.959	2	2.060	1.815	6.250	6.500

Source: ASME B18.2.1, 1996

## Heavy Hex Bolts

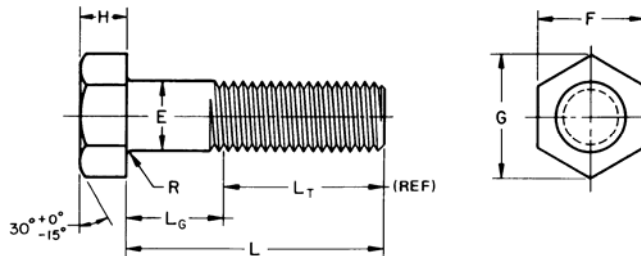

Nominal Size (inch)	E		F			G		H			Thread Length For Bolt Lengths	
	Full Size Body Dia.		Width Across Flats			Width Across Corners		Head Height			6 in & Shorter	Over 6 in
	Max.	Min.	Basic	Max.	Min.	Max.	Min.	Basic	Max.	Min.	Nom.	Nom.
1/2	0.515	0.482	7/8	0.875	0.850	1.010	0.969	11/32	0.364	0.302	1.250	1.500
5/8	0.642	0.605	11/16	0.688	1.031	1.227	1.175	27/64	0.444	0.378	1.500	1.750
3/4	0.768	0.729	1 1/4	1.250	1.212	1.443	1.383	1/2	0.524	0.455	1.750	2.000
7/8	0.895	0.852	1 7/16	1.438	1.394	1.660	1.589	37/64	0.604	0.531	2.000	2.250
1	1.022	0.976	1 5/8	1.625	1.575	1.876	1.796	43/64	0.700	0.591	2.250	2.500
1 1/8	1.149	1.098	1 13/16	1.813	1.756	2.093	2.002	3/4	0.780	0.658	2.500	2.750
1 1/4	1.277	1.223	2	2.000	1.938	2.309	2.209	27/32	0.876	0.749	2.750	3.000
1 3/8	1.404	1.345	2 3/16	2.188	2.119	2.526	2.416	29/32	0.940	0.810	3.000	3.250
1 1/2	1.531	1.470	2 3/8	2.375	2.300	2.742	2.622	1	1.036	0.902	3.250	3.500
1 3/4	1.785	1.716	2 3/4	2.750	2.662	3.175	3.035	1 5/32	1.196	1.054	3.750	4.000
2	2.039	1.964	3 1/8	3.125	3.025	3.608	3.449	1 11/32	1.388	1.175	4.250	4.500

Source: ASME B18.2.1, 1996

## Hex Cap Screws

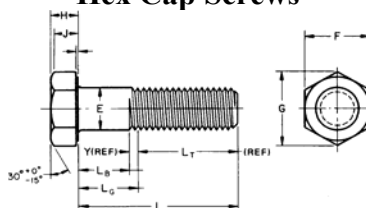

Nominal Size (inch)	E		F			G		H			Thread Length For Bolt Lengths (see chart below)	
	Full Size Body Dia.		Width Across Flats			Width Across Corners		Head Height			6 in & Shorter	Over 6 in
	Max.	Min.	Basic	Max.	Min.	Max.	Min.	Basic	Max.	Min.	Nom.	Nom.
1/4	0.2500	0.2450	7/16	0.438	0.428	0.505	0.488	5/32	0.163	0.150	0.750	1.000
5/16	0.3125	0.3065	1/2	0.500	0.489	0.577	0.557	13/64	0.211	0.195	0.875	1.125
3/8	0.3750	0.3690	9/16	0.563	0.551	0.650	0.628	15/64	0.243	0.226	1.000	1.250
7/16	0.4375	0.4305	5/8	0.625	0.612	0.722	0.698	9/32	0.291	0.272	1.125	1.375
1/2	0.5000	0.4930	3/4	0.750	0.736	0.866	0.840	5/16	0.323	0.302	1.250	1.500
9/16	0.5625	0.5545	13/16	0.813	0.798	0.938	0.910	23/64	0.371	0.348	1.375	1.625
5/8	0.6250	0.6170	15/16	0.938	0.922	1.083	1.051	25/64	0.403	0.378	1.500	1.750
3/4	0.7500	0.7410	1 1/8	1.125	1.100	1.299	1.254	15/32	0.483	0.455	1.750	2.000
7/8	0.8750	0.8660	1 5/16	1.313	1.285	1.516	1.465	35/64	0.563	0.531	2.000	2.250
1	1.0000	0.9900	1 1/2	1.500	1.469	1.732	1.675	39/64	0.627	0.591	2.250	2.500
1 1/8	1.1250	1.1140	1 11/16	1.688	1.631	1.949	1.859	11/16	0.718	0.658	2.500	2.750
1 1/4	1.2500	1.2390	1 7/8	1.875	1.812	2.165	2.066	25/32	0.813	0.749	2.750	3.000
1 3/8	1.3750	1.3630	2 1/16	2.063	1.994	2.382	2.273	27/32	0.878	0.810	3.000	3.250
1 1/2	1.5000	1.4880	2 1/4	2.250	2.175	2.598	2.480	1 5/16	0.974	0.902	3.250	3.500
1 3/4	1.7500	1.7380	2 5/8	2.625	2.538	3.031	2.893	1 3/32	1.134	1.054	3.750	4.000
2	2.0000	1.9880	3	3.000	2.900	3.464	3.306	1 7/32	1.263	1.175	4.250	4.500

Source: ASME B18.2.1, 1996

The length of thread on bolts shall be controlled by the grip gauging length ( $L_G$  max) and body length ( $L_B$  min). The thread length  $L_{Tc}$  is calculated as  $L_T = L$  nom. (nominal length) -  $L_G$  max. The minimum body length ( $L_B$  min) is the distance measured from the underhead bearing surface to the last scratch of thread or to the top of the extrusion angle.  $L_B = L_G$  max - transition thread length Y.

### Maximum Grip Gauging Lengths ( $L_G$ ) and Minimum Body Lengths ( $L_B$ ) for Hex Cap Screws

Nominal Diameter r	1/4		5/16		3/8		7/16		1/2		9/16		5/8		3/4		7/8		1	
Nominal Lengths	$L_G$	$L_B$	$L_G$	$L_B$	$L_G$	$L_B$	$L_G$	$L_B$	$L_G$	$L_B$	$L_G$	$L_B$	$L_G$	$L_B$	$L_G$	$L_B$	$L_G$	$L_B$	$L_G$	$L_B$
1 1/4	0.50	0.25																		
1 3/8	0.63	0.38	0.50	0.22																
1 1/2	0.75	0.50	0.62	0.35	0.50	0.19														
1 5/8	0.88	0.62	0.75	0.47	0.62	0.31														
1 3/4	1.00	0.75	0.88	0.60	0.75	0.44	0.63	0.27												
1 7/8	1.12	0.88	1.00	0.72	0.88	0.56	0.75	0.39	0.63	0.24										
2	1.25	1.00	1.12	0.85	1.00	0.69	0.88	0.52	0.75	0.38										
2 1/4	1.50	1.25	1.38	1.10	1.25	0.94	1.12	0.77	1.00	0.52	0.88	0.46	0.75	0.30						
2 1/2	1.75	1.50	1.62	1.35	1.50	1.19	1.38	1.02	1.25	0.86	1.12	0.75	1.00	0.55						
2 3/4	2.00	1.75	1.88	1.60	1.75	1.44	1.62	1.27	1.50	1.12	1.38	0.96	1.25	0.80	1.00	0.50				
3	2.25	2.00	2.12	1.85	2.00	1.69	1.88	1.52	1.75	1.36	1.62	1.21	1.50	1.05	1.25	0.75	1.00	0.44		
3 1/4	2.50	2.25	2.38	2.10	2.25	1.94	2.12	1.77	2.00	1.62	1.88	1.46	1.75	1.30	1.50	1.00	1.25	0.69	1.00	0.38
3 1/2	2.75	2.50	2.62	2.35	2.50	2.19	2.38	2.02	2.25	1.86	2.12	1.71	2.00	1.55	1.75	1.25	1.50	0.94	1.25	0.62
3 3/4	3.00	2.75	2.88	2.60	2.75	2.44	2.62	2.27	2.50	2.12	2.38	1.96	2.25	1.80	2.00	1.50	1.75	1.19	1.50	0.88
4	3.25	3.00	3.12	2.85	3.00	2.69	2.88	2.52	2.75	2.36	2.62	2.21	2.50	2.05	2.25	1.75	2.00	1.44	1.75	1.12
4 1/4	3.50	3.25	3.38	3.10	3.25	2.94	3.12	2.77	3.00	2.62	2.88	2.46	2.75	2.30	2.50	2.00	2.25	1.69	2.00	1.38
4 1/2	3.75	3.50	3.62	3.35	3.50	3.19	3.38	3.02	3.25	2.86	3.12	2.71	3.00	2.55	2.75	2.25	2.50	1.94	2.25	1.62
4 3/4	4.00	3.75	3.88	3.60	3.75	3.44	3.62	3.27	3.50	3.12	3.38	2.96	3.25	2.80	3.00	2.50	2.75	2.19	2.50	1.88
5	4.25	4.00	4.12	3.85	4.00	3.69	3.88	3.52	3.75	3.36	3.62	3.21	3.50	3.05	3.25	2.75	3.00	2.44	2.75	2.12
5 1/4	4.50	4.25	4.38	4.10	4.25	3.94	4.12	3.77	4.00	3.62	3.88	3.46	3.75	3.30	3.50	3.00	3.25	2.69	3.00	2.38
5 1/2	4.75	4.50	4.62	4.35	4.50	4.19	4.38	4.02	4.25	3.87	4.12	3.71	4.00	3.55	3.75	3.25	3.50	2.94	3.25	2.62
5 3/4	5.00	4.75	4.88	4.60	4.75	4.44	4.63	4.27	4.50	4.12	4.38	3.96	4.25	3.80	4.00	3.50	3.75	3.19	3.50	2.88
6	5.25	5.00	5.12	4.85	5.00	4.69	4.88	4.52	4.75	4.36	4.62	4.21	4.50	4.05	4.25	3.75	4.00	3.44	3.75	3.12
6 1/4	5.25	5.00	5.12	4.85	5.00	4.69	4.88	4.52	4.75	4.36	4.62	4.21	4.50	4.05	4.25	3.75	4.00	3.44	3.75	3.12
6 1/2	5.50	5.25	5.38	5.10	5.25	4.94	5.12	4.77	5.00	4.62	4.88	4.46	4.75	4.30	4.50	4.00	4.25	3.69	4.00	3.38
6 3/4	5.75	5.50	5.62	5.35	5.50	5.19	5.38	5.02	5.25	4.86	5.12	4.71	5.00	4.55	4.75	4.25	4.50	3.94	4.25	3.63
7	6.00	5.75	5.88	5.80	5.75	5.44	5.62	5.27	5.50	5.12	5.38	4.96	5.25	4.80	5.00	4.50	4.75	4.19	4.50	3.22

Note: screw lengths above black line are fully threaded.



### Hex Nuts and Hex Jam Nuts

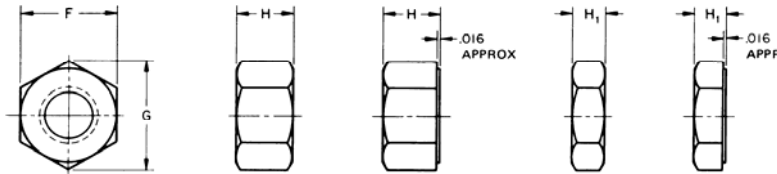

Nominal Size or Basic Major Dia. of Thread (in.)	F			G		H			H1		
	Width Across Flats (in.)			Width Across Corners (in.)		Thickness Hex Nuts (in.)			Thickness Hex Jam Nuts (in.)		
	Basic	Max.	Min.	Max.	Min.	Basic	Max.	Min.	Basic	Max.	Min.
1/4	7/16	0.438	0.428	0.505	0.488	7/32	0.226	0.212	5/32	0.163	0.150
5/16	1/2	0.500	0.489	0.577	0.557	17/64	0.273	0.258	3/16	0.195	0.180
3/8	9/16	0.562	0.551	0.650	0.628	21/64	0.337	0.320	7/32	0.227	0.210
7/16	11/16	0.688	0.675	0.794	0.768	3/8	0.385	0.365	1/4	0.260	0.240
1/2	3/4	0.750	0.736	0.866	0.840	7/16	0.448	0.427	5/16	0.323	0.302
9/16	7/8	0.875	0.861	1.010	0.982	31/64	0.496	0.473	5/16	0.324	0.301
5/8	15/16	0.938	0.922	1.083	1.051	35/64	0.559	0.535	3/8	0.387	0.363
3/4	1 1/8	1.125	1.088	1.299	1.240	41/64	0.665	0.617	27/64	0.446	0.398
7/8	1 5/16	1.312	1.269	1.516	1.447	3/4	0.776	0.724	31/64	0.510	0.458
1	1 1/2	1.500	1.450	1.732	1.653	55/64	0.887	0.831	35/64	0.575	0.519
1 1/8	1 11/16	1.688	1.631	1.949	1.859	31/32	0.999	0.939	39/64	0.639	0.579
1 1/4	1 7/8	1.875	1.812	2.165	2.066	1 1/16	1.094	1.030	23/32	0.751	0.687
1 3/8	2 1/16	2.062	1.994	2.382	2.273	1 11/64	1.206	1.138	25/32	0.815	0.747
1 1/2	2 1/4	2.250	2.175	2.598	2.480	1 9/32	1.317	1.245	27/32	0.880	0.808

Source: ANSI/ASME B18.2.2, 1986

### Heavy Hex Nuts and Heavy Hex Jam Nuts

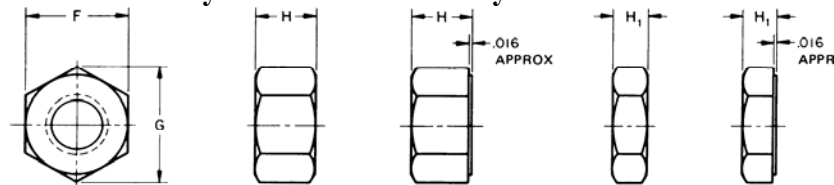

Nominal Size or Basic Major Dia. of Thread (in.)	F			G		H			H1		
	Width Across Flats (in.)			Width Across Corners (in.)		Thickness Heavy Hex Nuts (in.)			Thickness Heavy Hex Jam Nuts (in.)		
	Basic	Max.	Min.	Max.	Min.	Basic	Max.	Min.	Basic	Max.	Min.
1/4	1/2	0.500	0.488	0.577	0.556	15/64	0.250	0.218	11/64	0.188	0.156
5/16	9/16	0.562	0.546	0.650	0.622	19/64	0.314	0.280	13/64	0.220	0.186
3/8	11/16	0.688	0.669	0.794	0.763	23/64	0.377	0.341	15/64	0.252	0.216
7/16	3/4	0.750	0.728	0.866	0.830	27/64	0.441	0.403	17/64	0.285	0.247
1/2	7/8	0.875	0.850	1.010	0.969	31/64	0.504	0.464	19/64	0.317	0.277
9/16	15/16	0.938	0.909	1.083	1.037	35/64	0.568	0.526	21/64	0.349	0.307
5/8	1 1/16	1.062	1.031	1.227	1.175	39/64	0.631	0.587	23/64	0.381	0.337
3/4	1 1/4	1.250	1.212	1.443	1.382	47/64	0.758	0.710	27/64	0.446	0.398
7/8	1 7/16	1.438	1.394	1.660	1.589	55/64	0.885	0.833	31/64	0.510	0.458
1	1 5/8	1.625	1.575	1.876	1.796	63/64	1.012	0.956	35/64	0.575	0.519
1 1/8	1 13/16	1.812	1.756	2.093	2.002	1 7/64	1.139	1.079	39/64	0.639	0.579
1 1/4	2	2.000	1.938	2.309	2.209	1 7/32	1.251	1.187	23/32	0.751	0.687
1 3/8	2 3/16	2.188	2.119	2.526	2.416	1 11/32	1.378	1.310	25/32	0.815	0.747
1 1/2	2 3/8	2.375	2.300	2.742	2.622	1 15/32	1.505	1.433	27/32	0.880	0.808
5/8	2 9/16	2.562	2.481	2.959	2.828	1 19/32	1.632	1.556	29/32	0.944	0.868
1 3/4	2 3/4	2.750	2.662	3.175	3.035	1 23/32	1.759	1.679	31/32	1.009	0.929
1 7/8	2 15/16	2.938	2.844	3.392	3.242	1 27/32	1.886	1.802	1 1/32	1.073	0.989
2	3 1/8	3.125	3.025	3.608	3.449	1 31/32	2.013	1.925	1 3/32	1.138	1.050

Source ANSI/ASME B18.2.2, 1986

## Plain Low Carbon Washer Dimensions

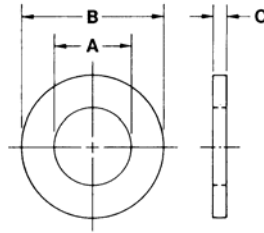

The thru-hardened SAE and USS flat washers will have the same basic dimensions with a tighter tolerance.

Nominal Washer Size	Style	(A) Inside Diameter			(B) Outside Diameter			(C) Thickness		
		Basic	Tolerance		Basic	Tolerance		Basic	Max.	Min.
			Plus	Minus		Plus	Minus			
1/4	SAE	0.281	0.015	0.005	0.625	0.015	0.005	0.065	0.080	0.051
1/4	USS	0.321	0.015	0.005	0.734	0.015	0.007	0.065	0.080	0.051
5/16	SAE	0.344	0.015	0.005	0.688	0.015	0.007	0.065	0.080	0.051
5/16	USS	0.375	0.015	0.005	0.875	0.030	0.007	0.083	0.104	0.064
3/8	SAE	0.406	0.015	0.005	0.812	0.015	0.007	0.065	0.080	0.051
3/8	USS	0.438	0.015	0.005	1.000	0.030	0.007	0.083	0.104	0.064
7/16	SAE	0.469	0.015	0.005	0.922	0.015	0.007	0.065	0.080	0.051
7/16	USS	0.500	0.015	0.005	1.250	0.030	0.007	0.083	0.104	0.064
1/2	SAE	0.531	0.015	0.005	1.062	0.030	0.007	0.095	0.121	0.074
1/2	USS	0.562	0.015	0.005	1.375	0.030	0.007	0.109	0.132	0.086
9/16	SAE	0.594	0.015	0.005	1.156	0.030	0.007	0.095	0.121	0.074
9/16	USS	0.625	0.015	0.005	1.469	0.030	0.007	0.109	0.132	0.086
5/8	SAE	0.656	0.030	0.007	1.312	0.030	0.007	0.095	0.121	0.074
5/8	USS	0.688	0.030	0.007	1.750	0.030	0.007	0.134	0.160	0.108
3/4	SAE	0.812	0.030	0.007	1.469	0.030	0.007	0.134	0.160	0.108
3/4	USS	0.812	0.030	0.007	2.000	0.030	0.007	0.148	0.177	0.122
7/8	SAE	0.938	0.030	0.007	1.750	0.030	0.007	0.134	0.160	0.108
7/8	USS	0.938	0.030	0.007	2.250	0.030	0.007	0.165	0.192	0.136
1	SAE	1.062	0.030	0.007	2.000	0.030	0.007	0.134	0.160	0.108
1	USS	1.062	0.030	0.007	2.500	0.030	0.007	0.165	0.192	0.136
1 1/8	SAE	1.250	0.030	0.007	2.250	0.030	0.007	0.134	0.160	0.108
1 1/8	USS	1.250	0.030	0.007	2.750	0.030	0.007	0.165	0.192	0.136
1 1/4	SAE	1.375	0.030	0.007	2.500	0.030	0.007	0.165	0.192	0.136
1 1/4	USS	1.375	0.030	0.007	3.000	0.030	0.007	0.165	0.192	0.136
1 3/8	SAE	1.500	0.030	0.007	2.750	0.030	0.007	0.165	0.192	0.136
1 3/8	USS	1.500	0.045	0.010	3.250	0.045	0.010	0.180	0.213	0.153
1 1/2	SAE	1.625	0.030	0.007	3.000	0.030	0.007	0.165	0.192	0.136
1 1/2	USS	1.625	0.045	0.010	3.500	0.045	0.010	0.180	0.213	0.153

Source: ANSI/ASME B18.22.1, 1965 (R1981)

## Round Head Square Neck Bolts (Carriage Bolt)

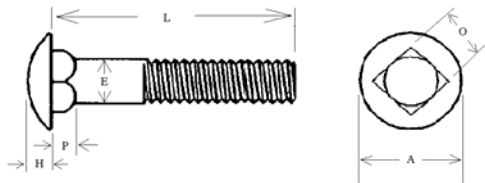

Nominal Size		E		A		H		O		P	
		Body Dia.		Head Dia.		Head Height		Square Width		Square Depth	
		Max	Min	Max	Min	Max	Min	Max	Min	Max	Min
No. 10	0.1900	0.199	0.182	0.469	0.438	0.114	0.094	0.199	0.185	0.125	0.094
1/4	0.2500	0.260	0.237	0.594	0.563	0.145	0.125	0.260	0.245	0.156	0.125
5/16	0.3125	0.324	0.298	0.719	0.688	0.176	0.156	0.324	0.307	0.187	0.156
3/8	0.3750	0.388	0.360	0.844	0.782	0.208	0.188	0.388	0.368	0.219	0.188
7/16	0.4375	0.452	0.421	0.969	0.907	0.239	0.219	0.452	0.431	0.250	0.219
1/2	0.5000	0.515	0.483	1.094	1.032	0.270	0.250	0.515	0.492	0.281	0.250
5/8	0.6250	0.642	0.605	1.344	1.219	0.344	0.313	0.642	0.616	0.344	0.313
3/4	0.7500	0.768	0.729	1.594	1.469	0.406	0.375	0.768	0.741	0.406	0.375

Source: ANSI/ASME B18.5, 1978

## Structural Bolting Heavy Hex Structural Bolt

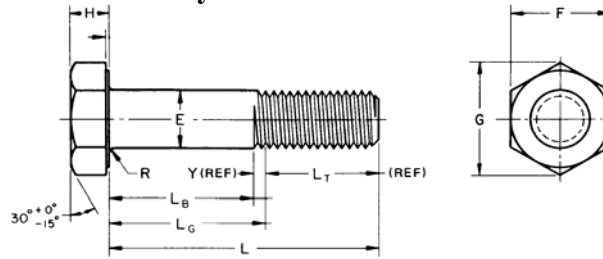

Nominal Size (inch)	E		F			G		H			Thread Length
	Full Size Body Dia.		Width Across Flats			Width Across Corners		Head Height			
	Max.	Min.	Basic	Max.	Min.	Max.	Min.	Basic	Max.	Min.	
1/2	0.515	0.482	7/8	0.875	0.850	1.010	0.969	5/16	0.323	0.302	1.00
5/8	0.642	0.605	1 1/16	1.063	1.031	1.227	1.175	25/64	0.403	0.378	1.25
3/4	0.768	0.729	1 1/4	1.250	1.212	1.443	1.383	15/32	0.483	0.455	1.38
7/8	0.895	0.852	1 7/16	1.438	1.394	1.660	1.589	35/64	0.563	0.531	1.50
1	1.022	0.976	1 5/8	1.625	1.575	1.876	1.796	39/64	0.627	0.591	1.75
1 1/8	1.149	1.098	1 13/16	1.813	1.756	2.093	2.002	11/16	0.718	0.658	2.00
1 1/4	1.277	1.223	2	2.000	1.938	2.309	2.209	25/32	0.813	0.749	2.00
1 3/8	1.404	1.345	2 3/16	2.188	2.119	2.526	2.416	27/32	0.878	0.810	2.25
1 1/2	1.531	1.470	2 3/8	2.375	2.300	2.742	2.622	15/16	0.974	0.902	2.25

Source: ASME B18.2.6, 1996

## Washers for High Strength Structural Bolts

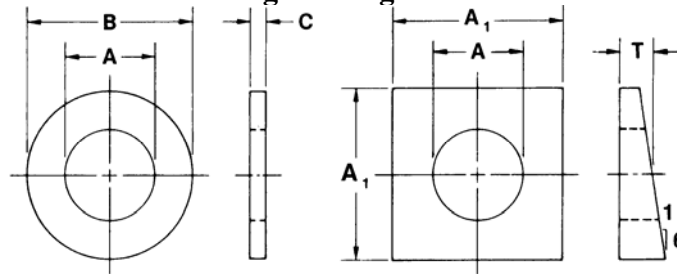

Bolt Size	Circular				Square Beveled		
	B	A	C		A1	A	T
	Nominal Outside Diameter (in.)	Nominal Inside Diameter (in.)	Thickness		Minimum Side Dimension (in.)	Nominal Inside Diameter (in.)	Mean Thickness Nominal (in.)
			Min. (in.)	Max. (in.)			
1/4	5/8	9/32	0.051	0.080			
5/16	11/16	11/32	0.051	0.080			
3/8	13/16	13/32	0.051	0.080			
7/16	59/64	15/32	0.051	0.080			
1/2	1 1/16	17/32	0.097	0.177	1 3/4	17/32	5/16
5/8	1 5/16	11/16	0.122	0.177	1 3/4	11/16	5/16
3/4	1 15/32	13/16	0.122	0.177	1 3/4	13/16	5/16
7/8	1 3/4	15/16	0.136	0.177	1 3/4	15/16	5/16
1	2	1 1/8	0.136	0.177	1 3/4	1 1/8	5/16
1 1/8	2 1/4	1 1/4	0.136	0.177	2 1/4	1 1/4	5/16
1 1/4	2 1/2	1 3/8	0.136	0.177	2 1/4	1 3/8	5/16
1 3/8	2 3/4	1 1/2	0.136	0.177	2 1/4	1 1/2	5/16
1 1/2	3	1 5/8	0.136	0.177	2 1/4	1 5/8	5/16

Source: ASTM F436, 1993

### Socket Head Cap Screws (1960 Series)

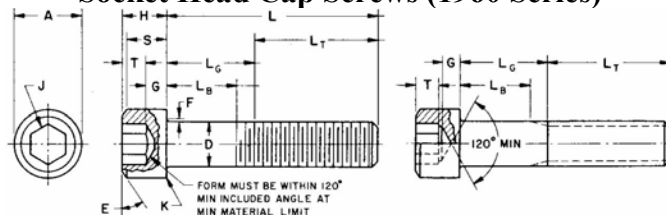

Nominal Size	D		A		H		J		T
	Body Dia.		Head Dia.		Head Height		Hexagon Socket Size Nom. (in.)		Key Engagement
	Max.	Min.	Max.	Min.	Max.	Min.		Min.	
0	0.060	0.0600	0.0568	0.096	0.091	0.060	0.057		0.025
1	0.073	0.0730	0.0695	0.118	0.112	0.073	0.070	1/16	0.031
2	0.086	0.0860	0.0822	0.140	0.134	0.086	0.083	5/64	0.038
3	0.099	0.0990	0.0949	0.161	0.154	0.099	0.095	5/64	0.044
4	0.112	0.1120	0.1075	0.183	0.176	0.112	0.108	3/32	0.051
5	0.125	0.1250	0.1202	0.205	0.198	0.125	0.121	3/32	0.057
6	0.138	0.1380	0.1329	0.226	0.218	0.138	0.134	7/64	0.064
8	0.164	0.1640	0.1585	0.270	0.262	0.164	0.159	9/64	0.077
10	0.190	0.1900	0.1840	0.312	0.303	0.190	0.185	5/32	0.090
1/4	0.250	0.2500	0.2435	0.375	0.365	0.250	0.244	3/16	0.120
5/16	0.313	0.3125	0.3053	0.469	0.457	0.312	0.306	1/4	0.151
3/8	0.375	0.3750	0.3678	0.562	0.550	0.375	0.368	5/16	0.182
7/16	0.438	0.4375	0.4294	0.656	0.642	0.438	0.430	3/8	0.213
1/2	0.500	0.5000	0.4919	0.750	0.735	0.500	0.492	3/8	0.245
5/8	0.625	0.6250	0.6163	0.938	0.921	0.625	0.616	1/2	0.307
3/4	0.750	0.7500	0.7406	1.125	1.107	0.750	0.740	5/8	0.370
7/8	0.875	0.8750	0.8647	1.312	1.293	0.875	0.864	3/4	0.432
1	1.000	1.0000	0.9886	1.500	1.479	1.000	0.988	3/4	0.495
1 1/8	1.125	1.1250	1.1086	1.688	1.665	1.125	1.111	7/8	0.557
1 1/4	1.250	1.2500	1.2336	1.875	1.852	1.250	1.236	7/8	0.620
1 3/8	1.375	1.3750	1.3568	2.062	2.038	1.375	1.360	1	0.682
1 1/2	1.500	1.5000	1.4818	2.250	2.224	1.500	1.485	1	0.745
1 3/4	1.750	1.7500	1.7295	2.625	2.597	1.750	1.734	1 1/4	0.870
2	2.000	2.0000	1.9870	3.000	2.970	2.000	1.983	1 1/2	0.995

Source ASME B18.3, 1998

### Socket Button Head Cap Screw

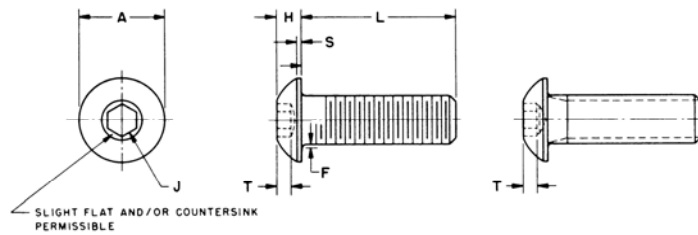

Nominal Size	A		H		J		T	L
	Head Dia.		Head Height		Hex Socket Size Nom.		Key Engagement	Max. Standard Length Nom.
	Max.	Min.	Max.	Min.		Min.		
0	0.060	0.114	0.104	0.032	0.026		0.035	0.50
1	0.073	0.139	0.129	0.039	0.033		0.050	0.50
2	0.086	0.164	0.154	0.046	0.038		0.050	0.50
3	0.099	0.188	0.176	0.052	0.044	1/16	0.062	0.50
4	0.112	0.213	0.201	0.059	0.051	1/16	0.062	0.50
5	0.125	0.238	0.226	0.066	0.058	5/64	0.078	0.50
6	0.138	0.262	0.250	0.073	0.063	5/64	0.078	0.63
8	0.164	0.312	0.298	0.087	0.077	3/32	0.094	0.75
10	0.190	0.361	0.347	0.101	0.091	1/8	0.125	1.00
1/4	0.250	0.437	0.419	0.132	0.122	5/32	0.156	1.00
5/16	0.3125	0.547	0.527	0.166	0.152	3/16	0.188	1.00
3/8	0.375	0.656	0.636	0.199	0.185	7/32	0.219	1.25
1/2	0.500	0.875	0.851	0.265	0.245	5/16	0.312	2.00
5/8	0.625	1.000	0.970	0.331	0.311	3/8	0.375	2.00

Source: ASME B18.3, 1998

### Socket Flat Countersunk Head Cap Screw

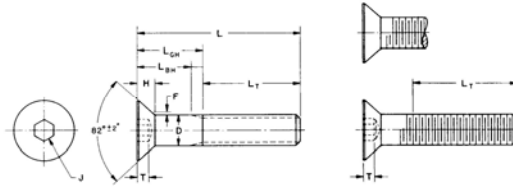

Nominal Size	D		A		H	J	T
	Body Dia.		Head Dia.		Head Height	Hexagon Socket	Key Engagement
	Max.	Min.	Theo. Sharp Max.	Abs. Min.	Ref.	Size Nom. (in.)	Min.
0	0.060	0.0600	0.0568	0.138	0.044		0.025
1	0.073	0.0730	0.0695	0.168	0.054		0.031
2	0.086	0.0860	0.0822	0.197	0.064		0.038
3	0.099	0.0990	0.0949	0.226	0.073	1/16	0.044
4	0.112	0.1120	0.1075	0.255	0.083	1/16	0.055
5	0.125	0.1250	0.1202	0.281	0.090	5/64	0.061
6	0.138	0.1380	0.1329	0.307	0.097	5/64	0.066
8	0.164	0.1640	0.1585	0.359	0.112	3/32	0.076
10	0.190	0.1900	0.1840	0.411	0.127	1/8	0.087
1/4	0.250	0.2500	0.2435	0.531	0.161	5/32	0.111
5/16	0.313	0.3125	0.3053	0.656	0.198	3/16	0.135
3/8	0.375	0.3750	0.3678	0.781	0.234	7/32	0.159
7/16	0.438	0.4375	0.4294	0.844	0.234	1/4	0.159
1/2	0.500	0.5000	0.4919	0.938	0.251	5/16	0.172
5/8	0.625	0.6250	0.6163	1.188	0.324	3/8	0.220
3/4	0.750	0.7500	0.7406	1.438	0.396	1/2	0.220
7/8	0.875	0.8750	0.8647	1.688	0.468	9/16	0.248
1	1.000	1.0000	0.9886	1.938	0.540	5/8	0.297

Source: ASME B18.3, 1998

### Socket Head Shoulder Screw

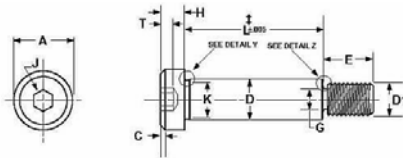

Nominal Size or Basic Shoulder Diameter	D		A		H		J	T	
	Shoulder Dia		Head Dia		Head Height		Hexagon Socket Size	Key Engagement	
	max	min	max	min	max	min	nom	min	
1/4	0.250	0.2480	0.2460	0.375	0.357	0.188	0.177	1/8	0.094
5/16	0.312	0.3105	0.3085	0.438	0.419	0.219	0.209	5/32	0.117
3/8	0.375	0.3730	0.3710	0.562	0.543	0.250	0.240	3/16	0.141
1/2	0.500	0.4980	0.4960	0.750	0.729	0.312	0.302	1/4	0.188
5/8	0.625	0.6230	0.6210	0.875	0.853	0.375	0.365	5/16	0.234
3/4	0.750	0.7480	0.7460	1.000	0.977	0.500	0.490	3/8	0.281
1	1.000	0.9980	0.9960	1.312	1.287	0.625	0.610	1/2	0.375

Nominal Size or Basic Shoulder Diameter	K	Shoulder Neck Diameter	Shoulder Neck Width	D1		Threads per inch	G		Thread Neck Width	E
				Nominal Thread Size or Basic Thread Diameter	Thread Diameter		Thread Neck Diameter	Thread Neck Width		
	min	max	max	max	min	max	min	max	Basic	
1/4	0.250	0.227	0.093	10	0.1900	24	0.142	0.133	0.083	0.375
5/16	0.312	0.289	0.093	1/4	0.2500	20	0.193	0.182	0.100	0.438
3/8	0.375	0.352	0.093	5/16	0.3125	18	0.249	0.237	0.111	0.500
1/2	0.500	0.477	0.093	3/8	0.3750	16	0.304	0.291	0.125	0.625
5/8	0.625	0.602	0.093	1/2	0.5000	13	0.414	0.397	0.154	0.750
3/4	0.750	0.727	0.093	5/8	0.6250	11	0.521	0.502	0.182	0.875
1	1.000	0.977	0.125	3/4	0.7500	10	0.638	0.616	0.200	1.000

Source: ASME B18.3, 2002

## Hexagon Socket Set Screws



Nominal Size or Basic Screw Diameter	J		T	C		R	Y		P		Q		Shortest Nominal Length to Which T Applies		
	Hexagon Socket Size		Key Engagement	Cup and Flat Point Diameters		Oval Point Radius	Cone Point Angle 90+/-2deg for these nom lengths or longer		Half Dog Point				Cup & Flat Points	Cone & Oval Points	Half Dog Point
	nom. (in.)			max	min		Basic	118+/-2deg for shorter nom lengths		Diameter		Length			
			min	max	min	max	min	max	min	max	min	max	min	max	min
0	0.060	0.028	0.050	0.033	0.027	0.045	0.09	0.040	0.037	0.017	0.013	0.13	0.13	0.13	
1	0.073	0.028	0.060	0.040	0.033	0.055	0.09	0.049	0.045	0.021	0.017	0.13	0.19	0.13	
2	0.086	0.035	0.060	0.047	0.039	0.064	0.13	0.057	0.053	0.024	0.020	0.13	0.19	0.19	
3	0.099	0.050	0.070	0.054	0.045	0.074	0.13	0.066	0.062	0.027	0.023	0.19	0.19	0.19	
4	0.112	0.050	0.070	0.061	0.051	0.084	0.19	0.075	0.070	0.030	0.026	0.19	0.19	0.19	
5	0.125	1/16	0.062	0.080	0.067	0.057	0.19	0.083	0.078	0.033	0.027	0.19	0.19	0.19	
6	0.138	1/16	0.062	0.080	0.074	0.064	0.19	0.092	0.087	0.038	0.032	0.19	0.25	0.19	
8	0.164	5/64	0.078	0.090	0.087	0.076	0.25	0.109	0.103	0.043	0.037	0.19	0.25	0.25	
10	0.190	3/32	0.094	0.100	0.102	0.088	0.25	0.127	0.120	0.049	0.041	0.19	0.25	0.25	
1/4	0.250	1/8	0.125	0.125	0.132	0.118	0.31	0.156	0.149	0.067	0.059	0.25	0.31	0.31	
5/16	0.313	5/32	0.156	0.156	0.172	0.156	0.38	0.203	0.195	0.082	0.074	0.31	0.44	0.38	
3/8	0.375	3/16	0.188	0.188	0.212	0.194	0.44	0.250	0.241	0.099	0.089	0.38	0.44	0.44	
7/16	0.438	7/32	0.219	0.219	0.252	0.232	0.50	0.297	0.287	0.114	0.104	0.44	0.63	0.50	
1/2	0.500	1/4	0.250	0.250	0.291	0.270	0.57	0.344	0.334	0.130	0.120	0.50	0.63	0.63	
5/8	0.625	5/16	0.312	0.312	0.371	0.347	0.75	0.469	0.456	0.164	0.148	0.63	0.88	0.88	
3/4	0.750	3/8	0.375	0.375	0.450	0.425	0.88	0.562	0.549	0.196	0.180	0.75	1.00	1.00	
7/8	0.875	1/2	0.500	0.500	0.530	0.502	1.00	0.656	0.642	0.227	0.211	0.88	1.00	1.00	
1	1.000	9/16	0.562	0.562	0.609	0.579	1.13	0.750	0.734	0.260	0.240	1.00	1.25	1.25	
1 1/8	1.125	9/16	0.562	0.562	0.689	0.655	1.25	0.844	0.826	0.291	0.271	1.25	1.50	1.25	
1 1/4	1.250	5/8	0.625	0.625	0.767	0.733	1.50	0.938	0.920	0.323	0.303	1.25	1.50	1.50	

Source ASME B18.3, 2002

## Hex Lag Screw

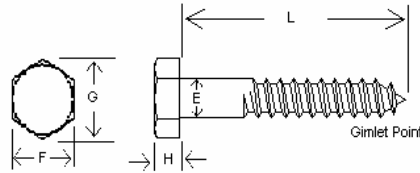

Nominal Size		Threads per Inch	E		F			G		H			S
			Body or Shoulder Dia.		Width Across Flats			Width Across Corners		Head Height			Shoulder Length
			Max	Min	Basic	Max	Min	Max	Min	Basic	Max	Min	Min
#10	0.1900	11	0.199	0.178	9/32	0.281	0.271	0.323	0.309	1/8	0.140	0.110	0.094
1/4	0.2500	10	0.260	0.237	7/16	0.438	0.425	0.505	0.484	11/64	0.188	0.150	0.094
5/16	0.3125	9	0.324	0.298	1/2	0.500	0.484	0.577	0.552	7/32	0.195	0.195	0.125
3/8	0.3750	7	0.388	0.360	9/16	0.562	0.544	0.650	0.620	1/4	0.226	0.226	0.125
7/16	0.4375	7	0.452	0.421	5/8	0.625	0.603	0.722	0.687	19/64	0.272	0.272	0.156
1/2	0.5000	6	0.515	0.482	3/4	0.750	0.725	0.866	0.826	11/32	0.302	0.302	0.156
5/8	0.6250	5	0.642	0.605	15/16	0.938	0.906	1.083	1.033	27/64	0.378	0.378	0.312
3/4	0.7500	4 1/2	0.768	0.729	1 1/8	1.125	1.088	1.299	1.240	1/2	0.455	0.455	0.375

Source: ASME B18.2.1, 1996

# Metric

## Metric Hex Cap Screws

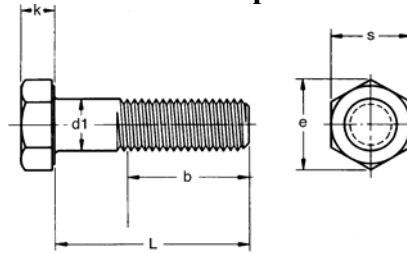

Nominal Size (mm)	d1			S			k				DIN 931 Thread Length For Bolt Lengths			
	Body Dia			Width Across Flats			Head Height				125mm & Shorter	Over 125mm & Less Than 200mm	Over 200mm	
	Max.	Grade A Min.	Grade B	Max. nom.	Grade A Min.	Grade B	Grade A Nom.	Grade A Min.	Grade A Max.	Grade B Min.	Grade B Max.	Nom.	Nom.	Nom.
3	3	2.86		5.5	5.32		2	1.88	2.12			12		
4	4	3.82		7	6.78		2.8	2.68	2.92			14		
5	5	4.82		8	7.78		3.5	3.35	3.65			16	22	
6	6	5.82		10	9.78		4	3.85	4.15			18	24	
7	7	6.78		11	10.73		4.8	4.65	4.95			20	26	
8	8	7.78		13	12.73		5.3	5.15	5.45			22	28	
10	10	9.78		17 (16)	16.73 (15.73)		6.4	6.22	6.58			26	32	45
12	12	11.73		19 (18)	18.67 (17.73)		7.5	7.32	7.68			30	36	49
14	14	13.73		22 (21)	21.67 (21.73)		8.8	8.62	8.98			34	40	53
16	16	15.73	15.57	24	23.67	23.16	10	9.82	10.18	9.71	10.29	38	44	57
18	18	17.73	17.57	27	26.67	26.16	11.5	11.28	11.72	11.15	11.85	42	48	61
20	20	19.67	19.48	30	29.67	29.16	12.5	12.28	12.72	12.15	12.85	46	52	65
22	22	21.67	21.48	32 (34)	31.61 (33.38)	31 (33)	14	13.78	14.22	13.65	14.35	50	56	69
24	24	23.67	23.48	36	35.38	35	15	14.78	15.22	14.65	15.35	54	60	73
27	27		26.48	41		40	17			16.65	17.35	60	66	79
30	30		29.48	46		45	18.7			18.28	19.12	66	72	85
33	33		32.38	50		49	21			20.58	21.42	72	78	91
36	36		35.38	55		53.8	22.5			22.08	22.92	78	84	97
39	39		38.38	60		58.8	25			24.58	25.42	84	90	103

Source: DIN 931: partially threaded, DIN 933: fully threaded

Grade A & Grade B: the specifications assign product grade A for thread sizes up to and including M24 and lengths smaller than 100 or 150mm, and assign to product grade B.

Width across flats does differ between specifications on M10, M12, M14 and M22. DIN 931 and DIN 933 are listed with ISO 4014 and 4017 in brackets.

## Metric Hex Nuts

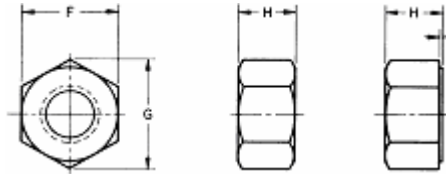

Nominal Size (mm)	Thread Pitch	F		G	H	
		Width Across Flats		Width Across Corners	Thickness	
		Max	Min	Min	Max	Min
1.6	0.35	3.2	3.02	3.41	1.3	1.05
2	0.4	4	3.82	4.32	1.6	1.35
2.5	0.45	5	4.82	5.45	2	1.75
3	0.5	5.5	5.32	6.01	2.4	2.15
4	0.7	7	6.78	7.66	3.2	2.9
5	0.8	8	7.78	8.79	4 (4.7)	3.7 (4.4)
6	1	10	9.78	11.05	5 (5.2)	4.7 (4.9)
8	1.25	13	12.73	14.38	6.5 (6.4)	6.14 (6.44)
10	1.5	17 (16)	16.73 (15.73)	18.9 (17.77)	8 (8.4)	7.64 (8.04)
12	1.75	19 (18)	18.67 (17.73)	21.1 (20.03)	10 (10.8)	9.64 (10.37)
14	2	22 (21)	21.67 (20.67)	24.49 (23.35)	11 (12.8)	10.3 (12.1)
16	2	24	23.67	26.75	13 (14.8)	12.3 (14.1)
20	2.5	30	29.16	32.95	16 (18)	14.9 (16.9)
24	3	36	35	39.55	19 (21.5)	17.7 (20.2)
30	3.5	46	45	50.85	24 (25.6)	22.7 (24.3)
36	4	55	53.8	60.79	29 (31)	27.4 (29.4)
42	4.5	65	63.1	71.3	34	32.4
48	5	75	73.1	82.6	38	36.4
56	5.5	85	82.8	93.56	45	43.4
64	6	95	92.8	104.86	51	49.1

Source: DIN 934

Dimensions differ between specifications on M10, M12, M14 between DIN 934 and ISO 4032. DIN 934 is listed with ISO 4032 in brackets.

### Metric Socket Head Cap Screw

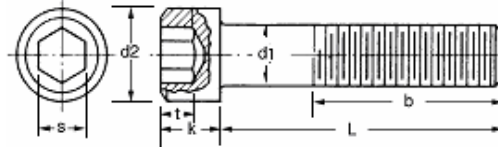

Nominal Size (mm)	d1		d2		k		s			t Key Engagement	b Thread Length Ref
	Body Dia		Head Diameter		Head Height		Socket Size				
	Max.	Min.	Max.	Min.	Max.	Min.	Nom	Max	Min	Min	
1.6	1.60	1.46	3.14	2.86	1.60	1.46	1.5	1.56	1.52	0.7	15
2	2.00	1.86	3.98	3.62	2.00	1.86	1.5	1.56	1.52	1	16
2.5	2.50	2.36	4.68	4.32	2.50	2.36	2	2.06	2.02	1.1	17
3	3.00	2.86	5.68	5.32	3.00	2.86	2.5	2.58	2.52	1.3	18
4	4.00	3.82	7.22	6.78	4.00	3.82	3	3.08	3.02	2	20
5	5.00	4.82	8.72	8.28	5.00	4.82	4	4.095	4.02	2.5	22
6	6.00	5.82	10.22	9.78	6.00	5.70	5	5.14	5.02	3	24
8	8.00	7.78	13.27	12.73	8.00	7.64	6	6.14	6.02	4	28
10	10.00	9.78	16.27	15.73	10.00	9.64	8	8.175	8.025	5	32
12	12.00	11.73	18.27	17.73	12.00	11.57	10	10.175	10.025	6	36
14	14.00	13.73	21.33	20.67	14.00	13.57	12	12.212	12.032	7	40
16	16.00	15.73	24.33	23.67	16.00	15.57	14	14.212	14.032	8	44
18	18.00	17.73	27.33	26.67	18.00	17.57	14	14.212	14.032	9	48
20	20.00	19.67	30.33	29.67	20.00	19.48	17	17.23	17.05	10	52
22	22.00	21.67	33.39	32.61	22.00	21.48	17	17.23	17.05	11	56
24	24.00	23.67	36.39	35.61	24.00	23.48	19	19.275	19.065	12	60
27	27.00	26.67	40.39	39.61	27.00	26.48	19	19.275	19.065	13.5	66
30	30.00	29.67	45.39	44.61	30.00	29.48	22	22.275	22.065	15.5	72
33	33.00	32.61	50.39	49.61	33.00	32.38	24	24.275	24.065	18	78
36	36.00	35.61	54.46	53.54	36.00	35.38	27	27.275	27.065	19	84
42	42.00	41.61	63.46	62.54	42.00	41.38	32	32.33	32.08	24	96

Source: DIN 912

### Metric Socket Button Head Cap Screw

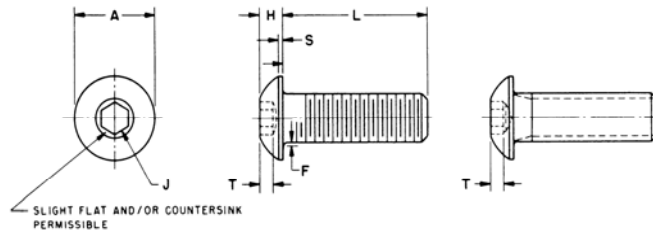

Nominal Size (mm)	A		H		J	T
	Head Dia.		Head Height		Hex Socket Size Nom.	Key Engagement Min.
	Max.	Min.	Max.	Min.		
3	5.7	5.4	1.65	1.4 (1.43)	2	1.04
4	7.60	7.24	2.20	1.95	2.5	1.3
5	9.50	9.14	2.75	2.50	3	1.56
6	10.50	10.07	3.3	3.0	4	2.08
8	14.00	13.57	4.4	4.1	5	2.6
10	17.50	17.07	5.5	5.2	6	3.12
12	21.00	20.48	6.60	6.24	8	4.16
16	28.00	27.48	8.80	8.44	10	5.2

Source: ISO 7380 (ANSI /ASME B18.3.4M)

The head height is identical between the ISO and ANSI specifications excluding M3 minimum. ISO is listed with ANSI in brackets.



### Metric Flat Washers

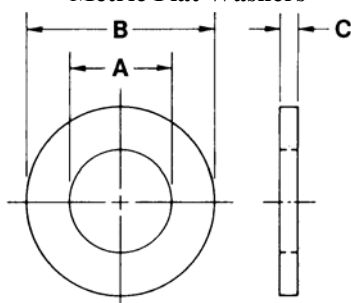

For Thread Size M	(A) Inside Diameter		(B) Outside Diameter		(C) Thickness		
	Min. = nominal size	Max.	Max. = nominal size	Min.	Nominal Size	Max.	Min.
1.6	1.7	1.84	4	3.7	0.3	0.35	0.25
2	2.2	2.34	5	4.7	0.3	0.35	0.25
2.5	2.7	2.84	6	5.7	0.5	0.55	0.45
3	3.2	3.38	7	6.64	0.5	0.55	0.45
3.5	3.7	3.88	8	7.64	0.5	0.55	0.45
4	4.3	4.48	9	8.64	0.8	0.9	0.7
5	5.3	5.48	10	9.64	1	1.1	0.9
6	6.4	6.62	12	11.57	1.6	1.8	1.4
7	7.4	7.62	14	13.57	1.6	1.8	1.4
8	8.4	8.62	16	15.57	1.6	1.8	1.4
10	10.5	10.77	20	19.48	2.0	2.2	1.8
12	13	13.27	24	23.48	2.5	2.7	2.3
14	15	15.27	28	27.48	2.5	2.7	2.3
16	17	17.27	30	29.48	3	3.3	2.7
18	19	19.33	34	33.38	3	3.3	2.7
20	21	21.33	37	36.38	3	3.3	2.7
22	23	23.33	39	38.38	3	3.3	2.7
24	25	25.33	44	43.38	4	4.3	3.7
26	27	27.33	50	49.38	4	4.3	3.7
27	28	28.33	50	49.38	4	4.3	3.7
30	31	31.39	56	55.26	4	4.3	3.7
33	34	34.62	60	58.8	5	5.6	4.4
36	37	37.62	66	64.8	5	5.6	4.4
39	40	40.62	72	70.8	6	6.6	5.4
42	43	43.62	78	76.8	7	8	6
45	46	46.62	85	83.6	7	8	6
48	50	50.62	92	90.6	8	9	7
50	52	52.74	92	90.6	8	9	7
52	54	54.74	98	96.6	8	9	7
56	58	58.74	105	103.6	9	10	8
64	66	66.74	115	113.6	9	10	8

Source: DIN 125

Type A, without chamfer: Type B, with external chamfer

## Other Screws

### Self-Drilling Screws

The point is designed to efficiently remove material and precisely size the hole for the thread. The length of the drill flute determines the metal thickness that can be drilled. The flute provides a channel for chip removal during removal during the drilling process. The point length, which is the unthreaded portion from the point to the first thread, should be long enough to assure the drilling action is complete before the first thread begins tapping into the drilled metal. Screw threads advance at a rate of up to ten times faster than the drill flute can remove metal. All drilling should be complete prior to forming the threads.

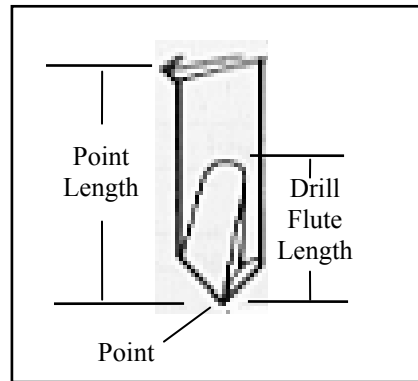

The following illustrates how to determine the thickness of the material to be drilled

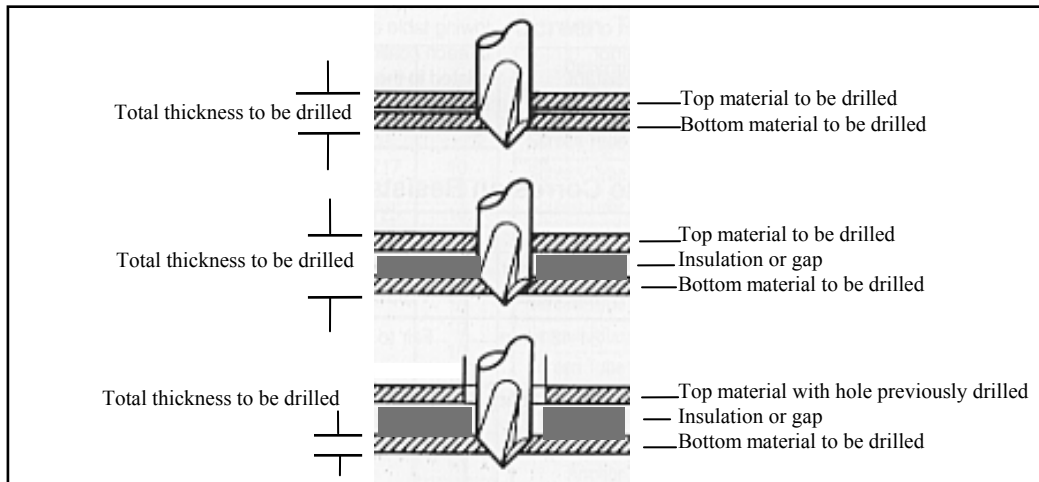

### Thread Length



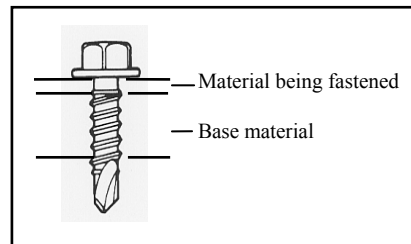

Choose a fastener with sufficient threads to fully engage in the base material. The head of the fastener provides the holding power for the material being fastened. It may be helpful, but not critical, that the threads also engage in the material being fastened. The threads provide the holding power in the base material.

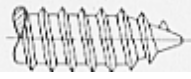

### Thread Pitch

The type of thread pitch to be used is determined by the thickness of the material to be fastened and the diameter of the screw. In general, the thinner the fastened material, the more threads needed, while the thicker the material, the fewer the number of threads needed. This is due to the fact that in thin metal, the upper and lower threads provide the clamp force. Most thicker materials will require a coarser thread. However, in thick metal ( $3/8''$  to  $1/2''$  thick), a fine thread may be required to tap into the base material and provide the greatest holding power.

## Types of Screw Points

General Thread Appearance	Type	Description
	A	A thread forming screw for use in thin metals 0.015 - 0.050 thick. Used with drilled, punched or nested holes in sheet metal, resin impregnated plywood, asbestos combinations, among others. Not recommended for new design.
	AB	A thread forming screw for use with heavier metal 0.050 - 0.200 thick. The finer thread pitch used with light and heavy sheet metal, non-ferrous castings, plastics, plywood, asbestos combinations.
	U	A thread forming screw with high Helix thread for driving or hammering into sheet metal, castings, fiber or plastics for permanent, quick assemblies.
	F	A thread cutting screw with machine screw thread having multi-cutting edges and chip cavities. For use in heavy gauge sheet metal, aluminum, zinc and lead die castings, cast iron, brass and plastic.
	BT 25	A thread cutting screw implementing a coarse Type B thread. Used with plastics and other soft materials with large chip clearing and cutting edges.
	T 23	A thread cutting screw with a fine thread offering maximum thread cutting area and excellent chip clearing with minimum tightening torque.

## Thread Rolling Screw

General Thread Appearance	Type	Description
	Tri-lobular	This thread rolling screw uses a tri-lobular design to cause the grains of the mating material to reform to the thread contour rather than be sheared during tapping. This action causes a stronger fit.

# Tri-Lobular Thread Forming Fasteners

## Suggested Hole Sizes at Percentages of Thread Engagement

### Inch Sizes

Nominal Screw Size	Pilot Hole Sizes Percent Thread Engagement													
	100%	95%	90%*	85%*	80%	75%	70%	65%	60%	55%	50%	45%	40%	35%
2-56	.0744	.0755	.0756	.0761	.0767	.0773	.0779	.0785	.0790	.0796	.0802	.0808	.0814	.0819
3-48	.0855	.0861	.0868	.0875	.0882	.0888	.0895	.0902	.0909	.0916	.0922	.0929	.0936	.0943
4-40	.0958	.0966	.0974	.0982	.0990	.0998	.1006	.1014	.1023	.1031	.1039	.1047	.1055	.1063
5-40	.1088	.1096	.1104	.1112	.1120	.1128	.1136	.1144	.1153	.1161	.1169	.1177	.1185	.1193
6-32	.1177	.1187	.1197	.1207	.1218	.1228	.1238	.1248	.1258	.1268	.1278	.1289	.1299	.1309
8-32	.1437	.1447	.1457	.1467	.1478	.1488	.1498	.1508	.1518	.1528	.1538	.1549	.1559	.1569
10-24	.1629	.1643	.1656	.1670	.1683	.1697	.1710	.1724	.1738	.1751	.1765	.1778	.1792	.1805
10-32	.1697	.1707	.1717	.1727	.1738	.1748	.1758	.1768	.1778	.1788	.1798	.1809	.1819	.1829
12-24	.1889	.1903	.1916	.1930	.1943	.1957	.1970	.1984	.1998	.2011	.2025	.2038	.2052	.2065
1/4-20	.2175	.2191	.2208	.2224	.2240	.2256	.2273	.2289	.2305	.2321	.2338	.2354	.2370	.2386
5/16-18	.2764	.2782	.2800	.2818	.2836	.2854	.2872	.2890	.2908	.2926	.2944	.2963	.2981	.2999
3/8-16	.3344	.3364	.3384	.3405	.3425	.3445	.3466	.3486	.3506	.3527	.3547	.3567	.3588	.3608
7/16-14	.3911	.3934	.3957	.3980	.4004	.4027	.4050	.4073	.4096	.4120	.4143	.4166	.4189	.4213
1/2-13	.4500	.4525	.4550	.4575	.4600	.4625	.4650	.4675	.4700	.4725	.4750	.4775	.4800	.4825

#### **SUGGESTED THREAD ENGAGEMENT GUIDELINES**

Powdered Metal or Cast Iron	50 - 65%
Cold Rolled Steel	65 - 70%
Aluminum	70 - 80%
Thin Sheet Metals	80 - 95%

\* - Pilot holes listed under the 90% and 85% thread engagement columns are recommended for single punch extruded holes. For pilot hole tolerance, +5% to -10% of the nominal value is recommended.

Approximate Hole Sizes for Type A Steel Thread Forming Screw				
In Steel, Stainless Steel, Monel Metal, Brass and Aluminum Sheet Metal				
Screw Size	Metal Thickness	Hole Required		
		Pierced or Extruded	Drilled or Clean Punched	Drill Size
6	0.015		0.104	37
	0.018		0.104	37
	0.024	0.111	0.104	37
	0.030	0.111	0.104	37
	0.036	0.111	0.106	36
7	0.015		0.116	32
	0.018		0.116	32
	0.024	0.120	0.116	32
	0.030	0.120	0.116	32
	0.036	0.120	0.116	32
	0.048	0.120	0.120	31
8	0.013		0.125	1/8
	0.024	0.136	0.125	1/8
	0.030	0.136	0.125	1/8
	0.036	0.136	0.125	1/8
	0.048	0.136	0.128	30
10	0.018		0.136	29
	0.024	0.157	0.136	29
	0.030	0.157	0.136	29
	0.036	0.157	0.136	29
	0.048	0.157	0.149	25
12	0.024		0.161	20
	0.030	0.185	0.161	20
	0.036	0.185	0.161	20
	0.048	0.185	0.161	20
14	0.024		0.185	13
	0.030	0.209	0.189	12
	0.036	0.209	0.191	11
	0.048	0.209	0.196	9

Approximate Pierced or Extruded Hole Sizes for Types AB and B Steel Thread Forming Screws					
In Steel, Stainless Steel, Monel Metal and Brass Sheet Metal			In Aluminum Alloy Sheet Metal		
Screw Size	Metal Thickness	Pierced or Extruded Hole	Screw Size	Metal Thickness	Pierced or Extruded Hole
0.018	0.111	0.030	0.111		
0.024	0.111	0.036	0.111		
0.030	0.111	0.048	0.111		
0.036	0.111				
7	0.018	0.120	7	0.024	0.120
	0.024	0.120		0.030	0.120
	0.030	0.120		0.036	0.120
	0.036	0.120		0.048	0.120
	0.048	0.120			
8	0.018	0.136	8	0.024	0.136
	0.024	0.136		0.030	0.136
	0.030	0.136		0.036	0.136
	0.036	0.136		0.048	0.136
	0.048	0.136			
10	0.018	0.157	10	0.024	0.157
	0.024	0.157		0.030	0.157
	0.030	0.157		0.036	0.157
	0.036	0.157		0.048	0.157
	0.048	0.157			
12	0.024	0.185	12	0.024	0.185
	0.030	0.185		0.030	0.185
	0.036	0.185		0.036	0.185
	0.048	0.185		0.048	0.185
1/4	0.030	0.209	1/4	0.030	0.209
	0.036	0.209		0.036	0.209
	0.048	0.209		0.048	0.209

Hole Sizes for metal thickness above 0.075 inch are for Type B only.

Approximate Drilled or Clean Punched Hole Sizes for Types AB and B Steel Thread Forming Screw							
In Steel, Stainless Steel, Monel Metal and Brass Sheet Metal				In Aluminum Alloy Sheet Metal			
Screw Size	Metal Thickness	Hole Required	Drill Size	Screw Size	Metal Thickness	Hole Required	Drill Size
6	0.015	0.104	37	6	0.030	0.104	37
	0.024	0.106	36		0.048	0.104	37
	0.036	0.110	35		0.060	0.106	36
	0.060	0.116	32		0.075	0.110	35
	0.075	0.120	31		0.105	0.111	34
	0.105	0.128	30		0.128-0.250	0.120	31
8	0.024	0.125	1/8	8	0.030	0.116	32
	0.036	0.125	1/8		0.060	0.136	29
	0.060	0.136	29		0.075	0.140	28
	0.075	0.140	28		0.105	0.147	26
	0.105	0.149	25		0.135	0.149	25
	0.135	0.152	24		0.162-0.375	0.152	24
10	0.024	0.144	27	10	0.036	0.144	27
	0.036	0.147	26		0.060	0.144	27
	0.060	0.152	24		0.075	0.147	26
	0.075	0.157	22		0.105	0.147	26
	0.105	0.161	20		0.125	0.154	23
	0.125	0.169	18		0.164	0.159	21
12	0.024	0.166	19	12	0.200-0.375	0.166	19
	0.036	0.166	19		0.048	0.161	20
	0.060	0.177	16		0.060	0.166	19
	0.075	0.182	14		0.075	0.173	17
	0.105	0.185	13		0.105	0.180	15
	0.125	0.196	9		0.125	0.182	14
1/4	0.030	0.194	10	1/4	0.135	0.182	14
	0.048	0.194	10		0.164	0.189	12
	0.060	0.199	8		0.196	0.196	9
	0.075	0.204	6		0.200-0.375	0.196	9
	0.105	0.209	4		0.060	0.199	8
	0.125	0.228	1		0.075	0.201	7
15/64"	0.135	0.228	1	0.105	0.204	6	
	0.164	0.234	15/64"	0.125	0.209	4	
	0.194	0.234	15/64"	0.135	0.209	4	
				0.164	0.213	3	
				0.187	0.213	3	
			0.194	0.221	2		
			0.200-0.375	0.228	1		

Since conditions may differ, it may be necessary to vary the hole size to suit a particular application.

Approximate Hole Sizes for Types F and T23 Steel Thread Cutting Screw											
Screw Size	Stock Thickness										
	0.050	0.060	0.083	0.109	0.125	0.140	3/16	1/4	5/16	3/8	1/2
Standard Drill Sizes for Holes in Steel											
6-32	0.1100	0.1130	0.1160	0.1160	0.1160	0.1200	0.1250	0.1250			
8-32	0.1360	0.1405	0.1405	0.1440	0.1440	0.1470	0.1495	0.1495	0.1495		
10-24	0.1520	0.1540	0.1610	0.1610	0.1660	0.1695	0.1730	0.1730	0.1730	0.1730	
10-32	0.1590	0.1660	0.1660	0.1695	0.1695	0.1695	0.1770	0.1770	0.1770	0.1770	
12-24		0.1800	0.1820	0.1875	0.1910	0.1910	0.1990	0.1990	0.1990	0.1990	0.1990
1/4-20			0.2130	0.2188	0.2210	0.2210	0.2280	0.2280	0.2280	0.2280	0.2280
1/4-28			0.2210	0.2280	0.2280	0.2340	0.2344	0.2344	0.2344	0.2344	0.2344
5/16-18				0.2770	0.2770	0.2813	0.2900	0.2900	0.2900	0.2900	0.2900
5/16-24				0.2900	0.2900	0.2900	0.2950	0.2950	0.2950	0.2950	0.2950
3/8-16					0.3390	0.3390	0.3480	0.3480	0.3580	0.3580	0.3580
3/8-24					0.3480	0.3480	0.3580	0.3580	0.3580	0.3580	0.3580
Standard Drill Sizes for Holes in Aluminum											
6-32	0.1094	0.1094	0.1110	0.1130	0.1160	0.1160	0.1200	0.1250			
8-32	0.1360	0.1360	0.1360	0.1405	0.1405	0.1440	0.1470	0.1495	0.1495		
10-24	0.1495	0.1520	0.1540	0.1570	0.1590	0.1610	0.1660	0.1719	0.1730	0.1730	
10-32	0.1610	0.1610	0.1610	0.1660	0.1660	0.1660	0.1719	0.1770	0.1770	0.1770	
12-24		0.1770	0.1800	0.1820	0.1850	0.1875	0.1910	0.1990	0.1990	0.1990	0.1990
1/4-20			0.2055	0.2090	0.2130	0.2130	0.2210	0.2280	0.2280	0.2280	0.2280
1/4-28			0.2188	0.2210	0.2210	0.2210	0.2280	0.2344	0.2344	0.2344	0.2344
5/16-18				0.2660	0.2720	0.2720	0.2810	0.2900	0.2900	0.2900	0.2900
5/16-24				0.2810	0.2812	0.2812	0.2900	0.2950	0.2950	0.2950	0.2950
3/8-16					0.3281	0.3320	0.3390	0.3480	0.3480	0.3480	0.3480
3/8-24					0.3438	0.3438	0.3480	0.3580	0.3580	0.3580	0.3580
Standard Drill Sizes for Holes in Zinc and Aluminum Die Castings											
6-32	0.1160	0.1200	0.1200	0.1200	0.1200	0.1200	0.1200	0.1200			
8-32	0.1440	0.1440	0.1440	0.1440	0.1470	0.1470	0.1470	0.1495	0.1495		
10-24	0.1610	0.1660	0.1660	0.1660	0.1660	0.1660	0.1660	0.1695	0.1719	0.1719	
10-32	0.1695	0.1695	0.1719	0.1719	0.1719	0.1719	0.1719	0.1730	0.1730	0.1770	
12-24		0.1800	0.1910	0.1910	0.1910	0.1935	0.1935	0.1960	0.1960	0.1990	0.1990
1/4-20			0.2188	0.2188	0.2210	0.2210	0.2210	0.2280	0.2280	0.2280	0.2280
1/4-28			0.2280	0.2280	0.2280	0.2280	0.2280	0.2340	0.2340	0.2344	0.2344
5/16-18				0.2770	0.2810	0.2810	0.2810	0.2812	0.2900	0.2900	0.2900
5/16-24				0.2900	0.2900	0.2900	0.2900	0.2900	0.2950	0.2950	0.2950
3/8-16					0.3390	0.3390	0.3390	0.3438	0.3438	0.3438	0.3438
3/8-24					0.3480	0.3480	0.3480	0.3580	0.3580	0.3580	0.3580

Approximate Hole Size for Types BT Steel Thread Cutting Screws								
Stock Thickness	Screw Size							
	6-20	8-18	10-16	12-14	1/4-14	5/16-12	3/8-12	
0.125	0.1200	0.1490	0.1660	0.1910	0.2210	0.2810	0.344	
0.140	0.1200	0.1490	0.1660	0.1910	0.2210	0.2810	0.344	
3/16	0.1200	0.1490	0.1660	0.1910	0.2210	0.2810	0.344	
1/4	0.1250	0.1520	0.1695	0.1960	0.2280	0.2810	0.344	
5/16	0.1250	0.1520	0.1719	0.1960	0.2280	0.2900	0.348	
3/8			0.1719	0.1960	0.2280	0.2900	0.348	

Since conditions may differ, it may be necessary to vary the hole size to suit a particular application.